



KPS Petrol Pipe System

Installation manual: English
Version 9.1



1. Important installation points

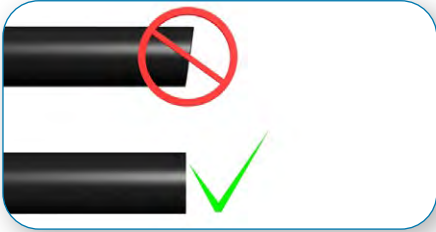

Pipes must be squarely cut and without burrs.



Remove surface oxidation.



Clean pipes and inside of fittings immediately before welding.

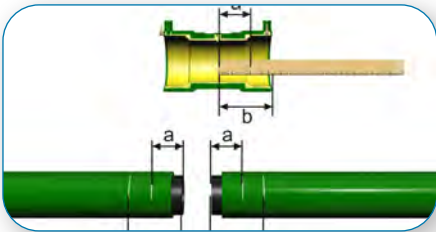

Carefully measure and mark insert depths of fittings.



When preparing to weld a double wall pipe, secure the inner and outer pipe in relation to each other before attaching the fitting, using a KPS clamping tool about 50 cm from the pipe end.

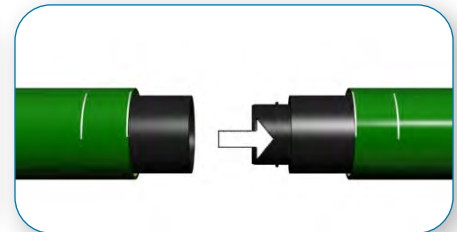

For conductive pipes, insert a KP CC in the joint.

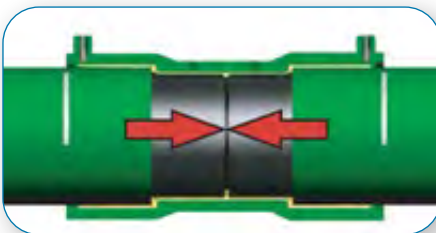

Make sure the pipes reach the bottom of the fitting.

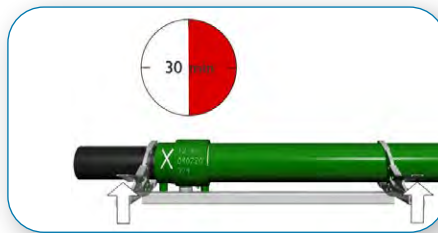

Use a welding fixture and make sure the parts to be welded are not subject to any kind of force during welding and cooling off period.



When using KPS conductive pipes, perform all relevant conductivity tests (before and after each weld) and make sure the system is properly grounded to earth.

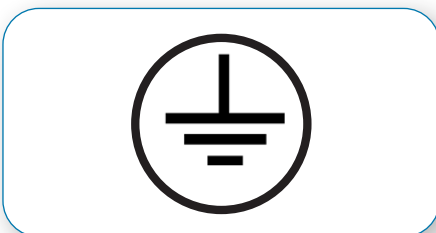

When using non-conductive pipes connect all conductors to earth and consult a competent electrical engineer for advice.



When installing, perform strength/pressure test to confirm the integrity of the piping system.



Perform tightness test with soaping before backfill and optionally also during and after backfill.

TABLE OF CONTENTS

1.	IMPORTANT INSTALLATION POINTS—2	
2.	OPW TECHNICAL SUPPORT—6	
3.	INTRODUCTION TO THE KPS PETROL PIPE SYSTEM™—7	
3.1	Product range	7
3.2	How to order	8
3.3	Warranty.....	8
3.4	Static electricity.....	9
4.	TRANSPORT, HANDLING & STORAGE—10	
4.1	On site	10
4.2	Pipe handling.....	11
5.	SYSTEM OVERVIEW—12	
5.1	Suction system.....	12
5.2	Pressure system	12
6.	INSTALLATION OVERVIEW—13	
6.1	Site preparations.....	13
6.2	Pipe installation	13
6.3	Testing and completion.....	13
7.	SITE PREPARATION & PIPE ARRANGEMENT—14	
7.1	Site readiness	14
7.2	Pipe arrangement & preparing trenches & beds.....	14
7.3	Uncoiling pipes	16
7.4	Uncoiler	16
8.	CUTTING PIPES—17	
8.1	Cutting tools	17
8.2	Cutting secondary contained pipes.....	18
8.3	Cutting formed bends	18
9.	WELDING—19	
9.1	Electrofusion welding.....	19
9.2	The welding machine	19
9.3	Preparations & welding.....	20
9.4	Welding two single wall pipes.....	21
9.5	Welding a single wall pipe & a plastic-to-steel transition fitting	22
9.6	Welding two double wall pipes with the integrated welding socket	23
9.7	Terminating secondary containment no joining	24
9.8	Terminating secondary containment for joining.....	25
9.9	Termination fittings without test port (KP T black).....	26

10. ENTRY SEALS—28	
10.1 General.....	28
10.2 Integrated entry seal & termination fitting.....	28
10.3 Rubber boot entry seal.....	28
10.4 Installation in tank	29
10.5 Installing threaded entry seals.....	30
10.6 Installing integrated entry seals & termination fittings	31
10.7 Installing integrated entry seal & termination fitting.....	33
10.8 Installing entry seal	35
11. CONNECTING THE END POINTS—36	
11.1 The plastic-to-steel transition fittings.....	36
11.2 Tank lid connections.....	37
11.3 Dispenser connection	37
11.4 Filling point.....	37
11.5 Ventilation stack connection	38
12. EARTHING AND STATIC ELECTRICITY—39	
12.1 Installing conductive pipes.....	39
12.2 Installing non-conductive systems.....	40
13. PRESSURE TESTING—42	
13.1 Pipe strength pressure test	42
13.2 Pipe tightness test - Before backfill (mandatory).....	43
13.3 Testing double-walled pipes	44
14. LEAK DETECTION—46	
15. COMPLETING THE INSTALLATION—47	
15.1 Documentation	47
15.2 Backfill	47
16. MODIFICATION AND REPAIR OF INSTALLATIONS—49	
16.1 Preparations & safety considerations	49
16.2 Modification of existing installations.....	49
16.3 Repair	49
16.4 Pressure testing after modification & repair	50
17. SAFETY CONSIDERATIONS—51	
17.1 Releasing & cutting coils	51
17.2 Use of equipment.....	51
17.3 Pressure testing.....	51
17.4 Repair, maintenance & upgrading work.....	51
17.5 Hazardous substances.....	52

- 18. MAIN UPDATES FROM VERSION 8.0—53
- 19. APPENDICES—53
 - 19.1 OPW suction line single wall example54
 - 19.2 OPW Suction line double wall example.....55
 - 19.3 OPW Pressure line example56
 - 19.4 OPW Fill line example57
 - 19.5 OPW Ventilation line and VR stage I example58
 - 19.6 OPW VR stage II example.....59
 - 19.7 Pipe installation checklist.....60
 - 19.8 Pipe test document.....61
 - 19.9 Pressure testing document.....62
- 20. EXTENDED WARRANTY—64
- 21. KPS PETROL PIPE SYSTEM CERTIFYING INSTALLER TRAINING—66
- 22. APPROVALS—67

Disclaimer

This document contains recommendations and information regarding KPS Petrol Pipe System™ products and their installation. It is based on currently available information and is believed to be representative under specific conditions. However, factors as environment, applications, installation or changes in operating procedure may cause different results. OPW makes no representation of warranty of any kind, express or implied, as to the accuracy, adequacy or completeness of the recommendations or information contained herein. OPW neither assumes nor authorizes any representative or other person to assume for it any obligation or liability other than such as is expressly set forth. Attention is drawn to any relevant local, national or regional regulations.

OPW reserves the right to update and revise this manual without prior notice. The current version is always published at <http://www.opwglobal.com>. OPW accepts no liability for installations that are not fully compliant with the instructions given in the current installation manual.

Revised: 2023-03

2. OPW Technical support

OPW Technical Support will help you make the best of the KPS products. We offer everything from basic installer training to sophisticated problem solving. When it is time for installation we offer on-site installation support for both new and experienced installers.

We will help you with:

- On-site installation support
- Advice on installation practices and product choice
- Specific or tailored installation solutions and drawings
- Standard installation examples
- Manuals and instructions
- And more...

For further information contact your nearest OPW technical support office, <http://www.opwglobal.com/emea/tech-support/>.



Christian Niejahr OPW Sweden assists an installer on site.

Documentation:

The latest versions of manuals, instructions, product catalogues and brochures can be downloaded at <http://www.opwglobal.com>.

3. Introduction to the KPS Petrol Pipe System™

The KPS Petrol Pipe System™ is a comprehensive range of products manufactured by OPW Sweden AB, a Swedish company with more than 30 years experience of manufacturing polyethylene pipes and fittings for the petroleum industry. OPW is represented worldwide by a network of partners, providing a full-range back up service.

The KPS Petrol Pipe System™ is a state-of-the-art, total solution for the handling of liquid fuel in underground polyethylene pipework systems, with features that address environmental, health and safety, life-span and economical concerns.

The KPS product range is expanding and developing continuously to adapt and conform to the ever more stringent demands of the market. By using state-of-the-art technology, the company offers highly competitive, long-term solutions with designs that have been developed to eliminate all leakage and electrostatic hazards.

The wide range of KPS products ensures that whatever your requirements are you will find the most appropriate solution. Whether working on suction or pressure systems, offset fills, vent lines or vapor recovery, we will always provide you with products you can trust.

The KPS Petrol Pipe System™ is suitable for all known liquid fuels, including petrol, diesel, ethanol and methanol in different grades and mixtures. Ask your OPW contact for advice about what metal components to use with pipes for ethanol and methanol mixed fuels and AdBlue.

OPW Sweden AB is certified to ISO 9001 and ISO 14001.

A KPS PE-based piping system has a burst pressure that well exceeds 40 bar. In effect, this means that compared to an average operating pressure of about 3.5 bar, the pipe system maintains more than a tenfold safety margin over time.

3.1 Product range

The KPS Petrol Pipe System™ includes:

- Pipes
- Welding sockets
- Bends, tees and reductions
- Transition fittings plastic to steel and steel fittings

- Electrical conduits
- Entry seals
- Overfill prevention and leak detection
- Installation tools and welding equipment
- Test equipment

For a complete listing, detailed descriptions, properties and dimensions, see the current OPW Product Catalogue, available for download at: www.opwglobal.com.

Unique permeation barrier

KPS pipes have a unique construction with layers chemically bonded on a molecular level. This technology is exclusive to OPW and by avoiding the use of an adhesive agent, as is common on the market, we can guarantee that the layers are inseparable.

This results in the most efficient permeation barrier on the market, preventing hydrocarbons from diffusing through the pipe wall. Thanks to our unique liner technology and our dedication to product quality, KPS was in 2005 the first company ever on the market to receive the EN 14125 approval. KPS Petrol Pipe System™ is also approved to the latest revision of UL 971.

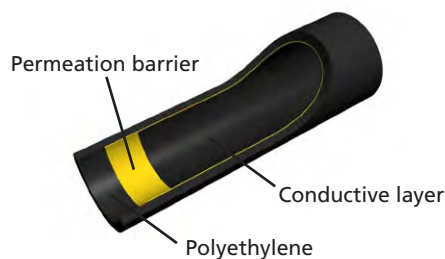

Conductive pipes

KPS conductive pipes have been specifically developed to address the risks of electrostatic hazards, a problem that oil and fuel companies are becoming increasingly aware of. The KPS conductive piping is our biggest and fastest growing product segment, as an increasing number of our customers appreciate the importance of eliminating risks related to static electricity.

KPS conductive pipes have many unique advantages. They are designed with an extra layer, a conductive inner liner that gives the pipes their conductive properties and the lowest permeation available on the market. As the pipes should be grounded to earth, static electricity can safely dissipate to earth, thus completely eliminating any risk related to static discharges and fires caused by static electricity in the pipe.

The conductive system includes conductivity connectors (KP CC) for joints as well as conductive plastic-to-metal transition fittings, making it possible to connect also the piping system to earth.

Our conductive pipes are approved to EN 14125, UL 971 and for use in Germany. It is the only plastic petrol pipe system to comply with the EN 13463-1 standard. This standard specifies the basic method and requirements for design, construction, testing and marking of non-electrical equipment intended for use in potentially explosive atmospheres.

As the first company ever, OPW have received an ATEX-certificate for a plastic petrol pipe system, stating that KPS's range of conductive pipes are compliant with the Atex 1999/92/EC User directive.

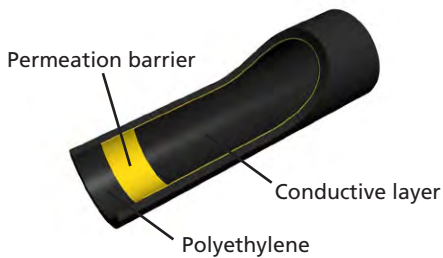

Secondary Contained Pipes

Our secondary contained pipes have been developed to provide extra environmental safety. By applying an outer, secondary pipe over the inner primary pipe, an interstitial space is created. A leak detection system can then be used to monitor the interstitial space for leaks.



The KP 315 Leak Detection System.

3.2 How to order

You can place your order by phone, e-mail or fax from you local OPW representative. To locate your nearest distributor, see information on our web site www.opwglobal.com.

3.3 Warranty

The KPS Petrol Pipe System™ has been developed to offer reliable performance over many years. Careful attention has been paid to minimizing the environmental impact during manufacture and during operation.

Warranty period (from dispatch from factory):

- 15 years on plastic pipes
- 15 years on plastic fittings
- 2 years on entry seals, transition fittings
- 1 year on other products and parts

Conditions:

- Handling, storage and installation must be done according to the installation manual
- Installation must be done by certified installers
- Fill in and save checklist
- Do not mix KPS products with pipes or fittings from other suppliers in one pipe run
- Only use KPS welding machine to weld KPS products

OPW accepts no liability for installations that fail to meet the conditions specified above, and failure to comply invalidates warranty and installer certification.

3.4 Static electricity

Conductive objects can have different electrical potential. When two conductive objects have a difference in potential and are close enough to each other there can be a discharge between these objects in the form of a spark.

At the filling station where fuel vapors may be present such a spark can ignite an explosive atmosphere. To prevent discharges from occurring, objects at the filling station should be kept at the same potential. This is achieved by making sure conductive objects are electrically connected to each other. When potential equalization has been correctly applied to all objects at the filling station, the risk of sparks from electrostatic discharges from the installation is minimized.

One problem is the use of non-conductive plastic pipes that cannot be electrically bonded and earthed due to the lack of electrical conductivity. The non-conductive pipes are also a source of static electricity. When petrol flows through a non-conductive pipe static electricity is created due to the friction between the petrol and the pipe wall. The amount of static electricity created depends on the flow rate of the fuel, the amount of turbulence and level of impurities in the petrol. The amount of turbulence depends on for example the pipe's inner surface characteristics, design of fittings and the use of elbows or bends.

The static charges accumulated on the pipe wall can lead to brush discharges either between the pipe wall and an earthed object, between the pipe wall and the fuel or between different areas on the pipe wall. These discharges often occur in a saturated atmosphere where there is not enough oxygen to create an explosive atmosphere, but can be dangerous if air enters the pipe, for example at the fill point.

The static charges also create an electrostatic field around the pipe where conductive objects that are not connected to earth will get an electrostatic potential. The difference in electrical potential between this object and another conductive object may lead to a spark discharge that can ignite an explosive atmosphere. This hazard can occur for example at the fill point or in a sump.

An easy way to prevent accumulation of static electricity created by fuel flow, as required by EN 14125, is to use conductive pipes.

When using KPS conductive piping system the charge is reduced to 1 million times less than in a non conductive piping system.

4. Transport, handling & storage

The KPS polyethylene pipes and fittings are of the highest quality, resilient and particularly suited for underground installation as the polyethylene material is strong, will not corrode like steel pipes or suffer from the microbes that are present in the ground. Nevertheless pipes and fittings need to be handled with care to prevent damage.

V-shaped scratches from sharp objects may weaken the polyethylene material and lead to propagating cracks.

- Protect pipes and fittings from scratches during loading, transport, unloading and storage.
- Keep products in their protective packaging until use.
- Use a flatbed vehicle for transport and stack products in an orderly and secure fashion.
- When lifting pipe racks, cover any sharp edges on forks of forklifts or use slings that cannot cause scratches to avoid damage to pipes or coils.

Polyethylene will expand slightly and become more flexible in high temperatures. Under cold conditions the material will shrink slightly and become stiffer.

- Coils should be stored flat, unless properly supported and secured, in order to avoid deformation of the pipe, especially in warm climates.



When coils are stored upright they need to be supported to avoid deformation of the pipe.

Polyethylene oxidizes in contact with air and exposure to UV radiation will speed up the process. The polyethylene oxide is not visible and cannot be welded like polyethylene. UV-radiation will also damage the permeation barrier.

- **Pipes that are stored outside for longer periods should be covered to protect them from UV radiation.**

- Pipes should always be stored with end caps on to protect from contamination and dirt.
- Fittings should be stored away from direct sunlight and kept in the protective plastic bag until ready for use.



End caps should be kept on the pipes until installation to protect from contamination and dirt.

Never install polyethylene products in contaminated soil as the contamination may cause swelling that can damage the pipe installation. Polyethylene will swell up to 3 % in volume when in direct contact with petrol. In underground installations swelling of the pipe can be restricted by pressure from backfill material, causing more swelling to occur lengthwise the pipe.

The pipes are protected on the inside by the permeation barrier that prevent direct contact with the petrol flowing in the pipe.

4.1 On site

- Inspect all material for damage upon delivery and before installation. Reject pipes with scratches deeper than 10% of the wall thickness or that show any other significant damage. Using material that has been damaged during transport, storage or handling will invalidate the warranty.
- Store pipe racks on clear level ground away from site traffic and supported by a bottom layer of timbers at 1 meter center to center.
- Do not stack pipe racks more than 4 racks high.
- Coils should be stored flat with suitable protection for the bottom of the coil.
- Do not stack coils more than 3 coils high.
- Never drag, roll or throw pipes or fittings.
- Never expose pipes or fittings to open flame or excessive heat, for example sparks from metallic welding or cutting.

4.2 Pipe handling

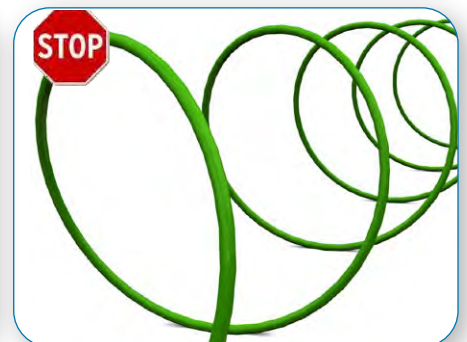
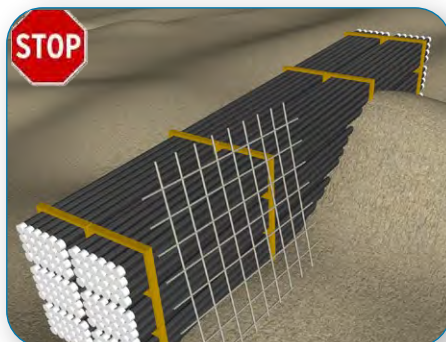
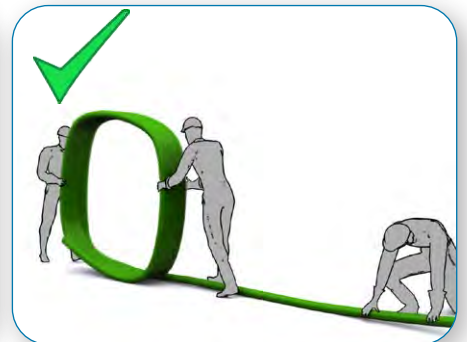
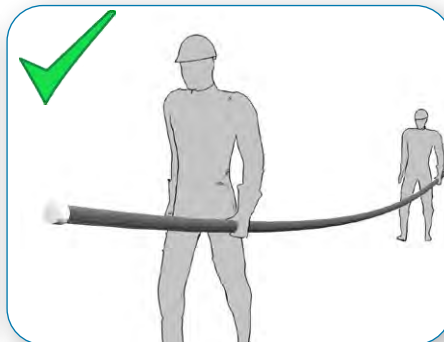
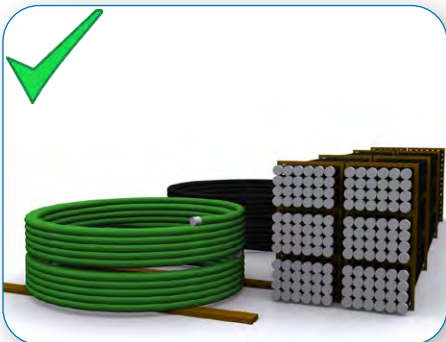
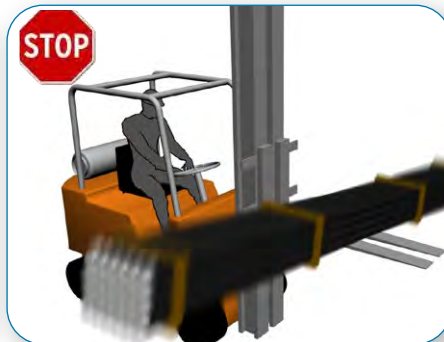
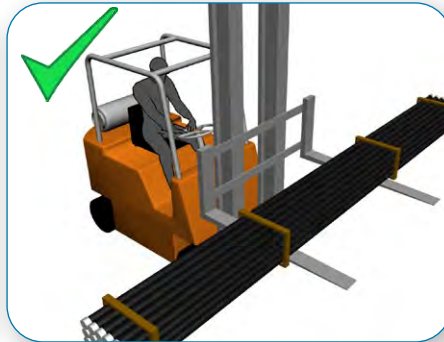

5. System overview

There are two different system types:

- Suction systems where there are pumps in the dispensers.
- Pressure systems where the pump is located in the tank.

5.1 Suction system

Fill line: The fill line has a gradient (minimum 1%) down to the tank. When the tanker truck drops its load, fuel flows down the fill line to the underground tank by the force of gravity. The fill line is only temporarily under pressure during the filling of the underground tank. Between the fills no fuel is present in the pipe.

Product lines: In a suction system there is usually one product line for each grade of fuel and dispenser. The product line has a gradient of minimum 1% going down from the dispenser end to the tank. A pump placed in the dispenser cabinet draws fuel from the tank when a car owner dispenses fuel to fill up his car.

5.2 Pressure system

Fill line: The system for fill lines is the same for pressure systems as for suction systems.

Product lines: In pressure systems a submerged pump located in the tank pumps fuel up the product line. The product line is under constant pressure, usually 3.5 bar. A pressure line can serve more than one dispenser and typically runs from one dispenser to another, meaning there will be one line only for each grade of fuel. The pressure line should have a gradient of minimum 1% going down from the last dispenser to the tank.

Hammer effects: When fuel is dispensed from the system, pressure spikes and surges occur in the piping system as valves open and close or a pump is started or shut off. The hammer effects are more severe in pressure systems and the forces can be up to 12 bars. The piping system has to be flexible to be able to absorb some of the hammer effect. The peak pressure from hammer effects can be minimized by using flexible pipe work. Plastic pipes have significantly better properties for this than steel or fibre glass pipes.

6. Installation overview

What is described below is a suggested, recommended workflow to minimize inconveniences during the installation of the piping system.

6.1 Site preparations

- Check that no fuel contamination is present.
- Check that you have the correct revision drawing.
- Check the availability and quality of the power supply.
- Tanks, vent, fill and dispenser frames should be positioned first and firmly fixed at the correct position in relation to the finished forecourt level.
- Install tank sumps and make sure tank lid steel fittings are in place.
- Pipe bed or trenches should be prepared and be at the right level for laying of the pipes with the correct gradient down to the tank sump. Ideally pipes can be laid directly onto the bed with only minor adjustments. Clean sand or pea gravel, diameter ≤ 16 mm, is approved material for bedding and backfill.
- Double-check levels and gradients before marking penetration points on the tank sump. Adjust bed or trenches if necessary.
- Uncoil pipes the day before installation and check that all necessary tools and equipment are available.

6.2 Pipe installation

It is not necessary that pipes are installed in the order described, but it helps to have a standard process to follow.

- Install fill lines, beginning from the tank end and work towards the fill point. Make sure there is enough space for all lines.
- Make sure the pipes are well supported during the installation.
- Install vent lines and vapor recovery stage 1 lines, beginning from the tank end and working towards the vent stack. If possible lay vent lines in the same trench as the fill lines.
- Install product lines, beginning from the tank and working towards the dispensers.
- Install vapor recovery stage 2 lines, beginning from the tank end and working towards the dispensers.

- Install electrical conduits, with a gradient away from any building they enter. Seal conduits at the end points to prevent fuel and fuel vapors from entering.

Start with installing the longest pipe run. Then if you make a mistake, you can use the pipe for the next long pipe run.

Work on parallel lines to allow each weld to cool down before continuing work on the pipe run.

6.3 Testing and completion

- When installing KPS conductive pipes, test all finished pipe lines for conductivity before connecting them to the end point.
- Perform pressure test of secondary and primary pipes to confirm the integrity and mechanical strength of the system.
- Perform tightness test of secondary and primary pipe work to test for leakage. Use soap solution to locate leakage.
- Provide earthing and bonding to equalize electrical potential of the underground piping system. Always consult a competent electrical engineer with good knowledge of local and regional rules and regulations.
- Fill in the installation checklist and other installation records, take photos to document the installation and provide an "as installed" drawing for documentation and for reference for future maintenance and upgrading work.
- Backfill carefully, ensuring each pipe is properly supported by the backfill material.

7. Site preparation & pipe arrangement

7.1 Site readiness

- Check that no fuel contamination is present.
- Check the availability and quality of the power supply. The welding machine KP 108B operates on standard alternating current. Normal, fixed power connections can be used on an electrically stable portable generator with a rated output of at least 4 kW. **The power input must be maintained between 230 V ~ ±15% (195,5 V – 264,5 V) at 45 – 65 Hz.** To check the input voltage keep the SELECT key pressed down.
- The steel structure and canopy should for safety reasons be completed or at least not worked on during pipe installation.
- Construction equipment and materials should be removed from the tank and piping area.
- Install tank chambers in accordance with the manufacturer's instructions.

7.2 Pipe arrangement & preparing trenches & beds

KPS pipes are designed for direct burial in the ground. They should normally not be laid in ducts made of steel, plastic, concrete or bricks or be used for any above ground application. Consult KPS before installing KPS pipes in other ways than those described and recommended in this manual.

Pipe trenches and bedding

The trenches should be dug out to provide a continuous gradient down to the tank of at least 1% (1 cm/meter). This applies to all pipe work for both suction and pressure systems to allow for operational performance as well as acceptable prerequisites for maintenance and repair work where pipes need to be emptied.

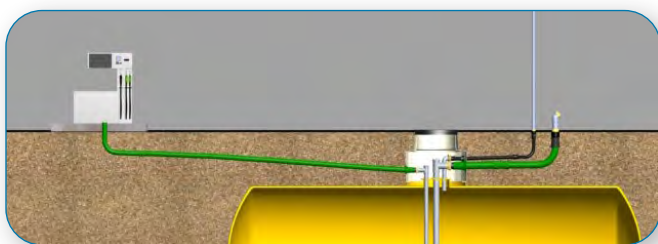

In suction systems a continuous gradient of the pipes is essential for operational functionality.

Trenches should then be prepared with a bottom layer of 10-15 cm of bedding material on which the pipes are then placed. The following materials are approved for bedding and backfill:

- Well rounded pea gravel, diameter ≤16 mm.
- Clean sand.



From left to right: Pea gravel and sand.

Do not use any other material, for example shingle, since it can cause damage to the pipes.

The best result is achieved when pipes are placed directly onto the bed. For minor adjustments of the gradient, use bags filled with backfill material, placed under the pipe at minimum 1 meter intervals, and always directly under any joints. Bags filled with backfill material should also be used to separate pipes that are crossing. Do not use wooden pieces as these will deteriorate over time leaving a void. Do not use stones or bricks as the sharp edges can damage the pipe. Styrofoam as a means of supporting or separating pipes should be avoided because the material will deteriorate fast if in contact with hydrocarbons. Pieces of plastic pipe risk being displaced during backfill and are often insufficient for pipe support, but can be used to separate parallel pipes.

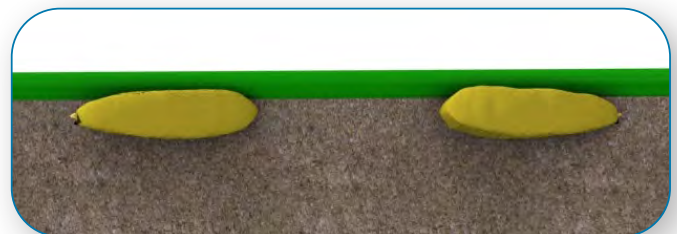

When pipes cannot be laid directly onto the bed, bags with sand should be used to support the pipe at close intervals.

If sand is used for bedding and backfill it will need to be mechanically compacted with a machine approximately every 20 cm. The optimal layer depth depends on the machine used. Saturating sand with water can help compacting, but is not sufficient as the only compacting method. Pea gravel is self-compacting making machine compacting unnecessary.

When calculating the depth and gradient of the trench, consider that when the installation is complete, the pipe should be buried at a minimum of 300 mm from the top of the pipe to finished forecourt level (250 mm when using reinforced concrete).

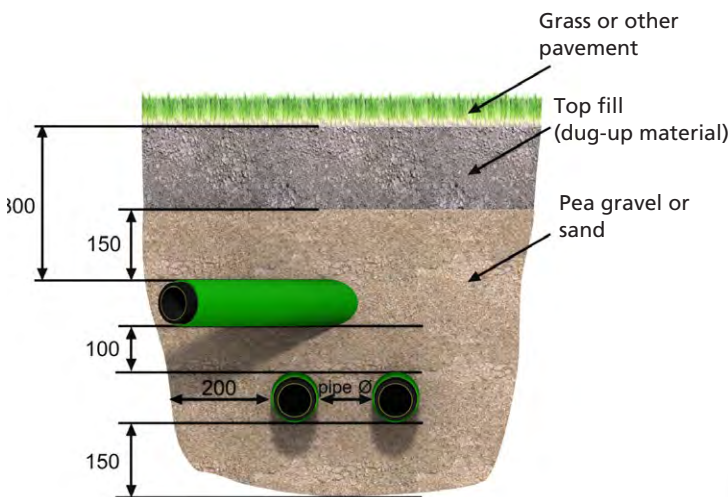

Minimum clearances for green area (no traffic).

In areas trafficked by vehicles weighing up to 60 tons, the burial depth should be increased to at least 600 mm. If the area is trafficked by vehicles over 60 tons, even deeper burial is needed. Follow standard requirements and regulations for ground work. If local regulations require deeper burial than specified by OPW, these regulations must be followed.

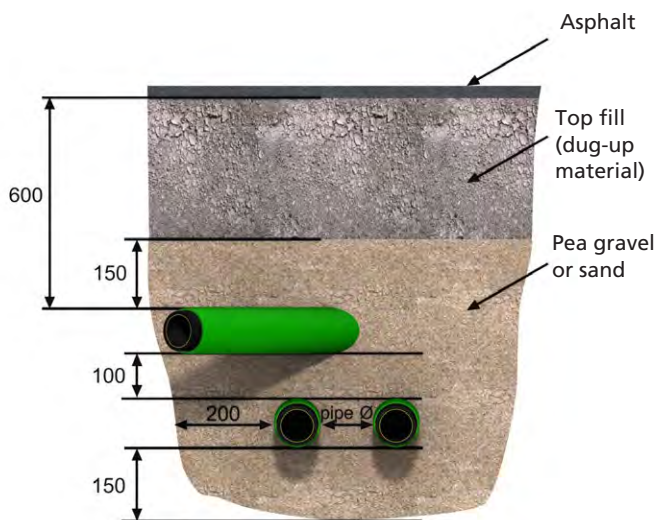

Minimum clearances for vehicles weighing up to 60 tons.

Dig trenches wide enough to lay pipes no closer than cm equal to the pipe diameter to each other and no closer than 20 cm to the side of the trench or any sharp object. When using coils, dig trenches that allow for soft bends rather than sharp 90° bends.

Pipe arrangement

Lay pipes on a bed of 10-15 cm of bedding material with a minimum of cm equal to the pipe diameter between parallel or crossing pipes and a distance of minimum 20 cm to the side of the trench or any sharp object.

OPW recommends the use of coiled pipes on long product lines to minimize the number of joints in the ground. For shorter lengths, for example in between the dispensers in a pressure system, straight pipes may be preferable to achieve the best entry angle into the dispenser sumps.



Coiled pipe laid in slight curves that allow the pipes to adjust to temperature changes or ground movement.

To compensate for movement of the pipe due to temperature changes or movement/settlement in the soil, lay coils in slight curves and end straight pipe lengths with a plastic bend under the fill point and at the tank sump.

Double-check levels and gradients before marking penetration points on the tank sump. Adjust bed or trenches if necessary.

Avoid:

- Unnecessary joints of pipes outside of sumps.
- Pipes crossing each other if another solution is possible using a different pipe layout.
- Burying metal parts in the soil.

The minimum bend radius of a pipe is 20 x the pipe diameter.

Pipe	Min. bend radius (mm)
KP 32	640
KP 40/32	800
KP 54	1080
KP 63	1260
KP 75/63	1500
KP 90	1800
KP 110	2200
KP 125/110	2500

7.3 Uncoiling pipes

Be careful when releasing coils as the pipe can straighten with considerable force. A minimum of two people is needed to uncoil the pipe. The end of the pipe should be constrained with a rope and a slipknot before cutting the bands around the coil.



One person should hold the pipe and another do the cutting.

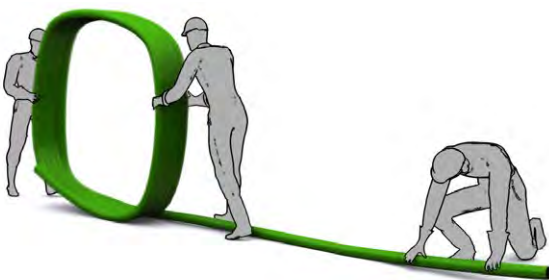

A good and safe way to roll out a pipe is with 3 people.



Avoid this way.

In colder climates coils could be gently pre-warmed before uncoiling either by being stored indoors in a heated building overnight or in a container with a construction heating fan. Take care to not subject the pipe to excessive heat (over 60°C) that may damage the material.



Straightening of coils.

7.4 Uncoiler

KP UC-01 is an accessory that eases the work of uncoiling. The uncoiler can be used on both tarmac, on a pallet or on dirty ground. It is easy to assemble and fits on a pallet when not mounted.

Could be used in combination with a tarpaulin and a construction heating fan in cold climate. Take care not to exceed heat over 60°C that will damage the pipes.



KP UC-01.



KP UC-01 in action.

8. Cutting pipes

8.1 Cutting tools

To ensure that pipes can be properly joined to other parts of the system it is important that they are cut absolutely square. Always cut pipes with the KPS approved tools. Never cut pipes using a saw-edged blade of any kind.



Pipes must be cut squarely to fit the welding socket.

Pipes up to 63 mm in diameter can be cut using the KPS pipe scissors. To use the cutter, place the curved section on top of the pipe and the cutting blade under the pipe. Positioning the scissors this way is important as it ensures a square cut. Keep the bottom handle still and use the upper handle to cut. Check that your cut is square.

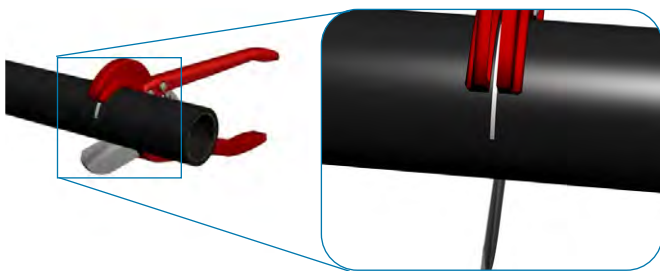

Pipe scissors can be used on pipes up to 63 mm in diameter.



CAUTION: To avoid personal injury, exercise caution when using cutting tools.

The KPS rotating pipe cutter can be used for pipes of all diameters from 48 mm up to 125 mm.

- Depress the release nut to open the cutter.
- Place the cutter with the rollers under the pipe and press the cutting wheel into contact with the pipe. Turn the cutting wheel feed knob clockwise half a turn.

- Rotate the cutter away from yourself and around the pipe for one lap. Turn the feed knob clockwise half a turn.
- Now rotate the cutter towards yourself and for each revolution turn the feed knob about 45° to press the cutting wheel further into the pipe. Repeat until the cut is completed.

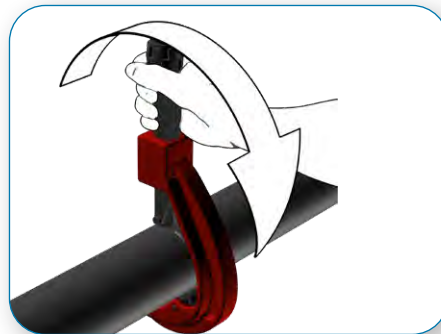

The rotating pipe cutter will cut the pipe absolutely square.



CAUTION: Be careful when cutting pipe that have been coiled, even if it has already been uncoiled as the cut ends tend to bend back into a curved form and risk hitting you or others causing injury. One person should do the cutting while another person holds the pipe.



NOTICE: If necessary, remove any burrs using the deburring tool that comes with the pipe cutter.

Do not use a regular knife to remove burrs, as there is a risk of unintentionally create v-shaped notches that may lead to cracks in the pipe.

To access the deburring tool, tip the cutter and press the release pin.

8.2 Cutting secondary contained pipes

When cutting a secondary contained pipe to the required length, both the inner and outer pipe can be cut at the same time, using the rotating pipe cutter.

When trimming off the outer pipe of secondary contained pipes, always measure carefully the insert depth of the fitting you are using. Take care not to damage the inner pipe when cutting the outer pipe.

8.3 Cutting formed bends

Formed bends are made of regular KPS pipe bent to 90° or 45°. When cutting a bend to desired length, make sure that you do not cut too close to the curved section. The part of the bend that is inserted into the welding socket must be completely straight and circular in shape. Make sure you don't cut back all the way to where the bend starts.

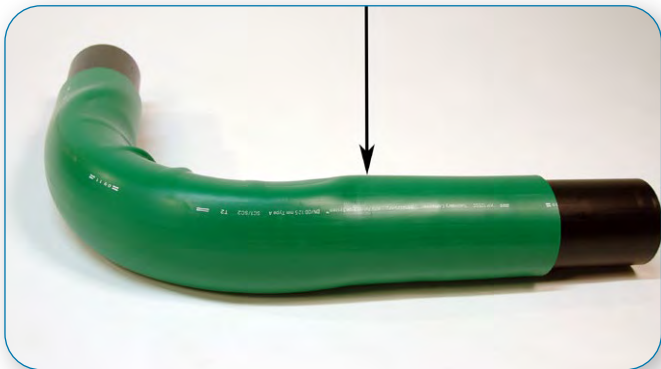

The part of the bend that is inserted into the welding socket must be completely straight and circular in shape.

9. Welding

9.1 Electrofusion welding

Polyethylene pipes and fittings in the KPS system are joined by electrofusion welding. The ambient temperature when welding can be done is between **-10°C and +45°C (14°F and +110°F)**. Do not weld under rainy or humid conditions, unless the pipe and socket can be kept absolutely dry. Water must not be present on the surface of the pipes or fittings to be welded. Avoid welding in direct sunlight as the pipes and socket may be of uneven temperature.

The principle of electrofusion welding is that a resistance wire just below the inner surface of the welding socket/fitting is heated to a temperature sufficient to melt the PE (polyethylene) material on the outer surface of the pipe and on the inside of the fitting.

The temperature inside the welding socket reaches about +200°C. Heat transfer in the polyethylene is slow and only the material in the vicinity of the wire is melted. The polyethylene expands during heating and the pressure in the fusion area increases as the surrounding cold material prevents the melt from expanding. Thus, a homogenous and strong fusion weld is created.

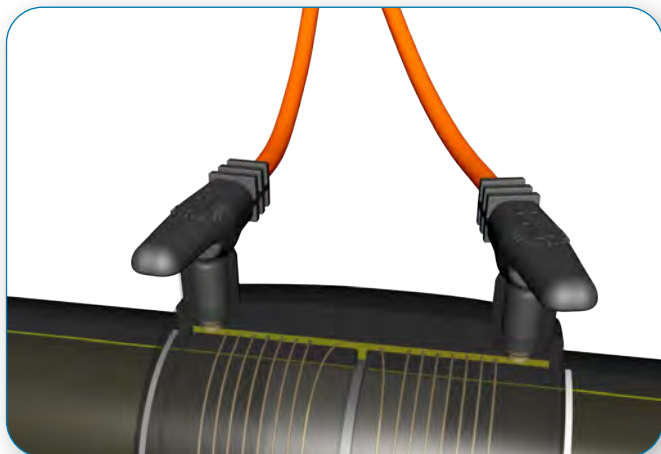

During electrofusion welding material is melted by the heat from the socket wiring and the pipe fuses with the welding socket.

In order for the welding to work properly the oxide layer that forms on all polyethylene surfaces of pipes, formed bends, tees and transition fittings, must first be removed as the oxide layer prevents fusion with the polyethylene on the inside of the welding socket. Polyethylene oxide is invisible, but present on all polyethylene surfaces that have come into contact with the air. More oxide is formed on surfaces subject to UV-radiation.



CAUTION: Do not weld where there is risk of flammable liquids or vapors. Always ensure that petrol or petrol vapors have been completely removed before welding.

9.2 The welding machine

The power, energy and welding times needed for welding are automatically calculated and applied when KPS welding machines and welding cables are used. Other welding machines or cables must not be used. The welding machine comes with two sets of cables, grey for 4 mm welding pins and orange for 2 mm welding pins.

Depending on the ambient temperature, the KPS welding machine will adjust the welding time for an optimal weld. The welding machine should be given 30 minutes to adjust to the working conditions before welding begins. Pipes, sockets and fittings to be welded should also be of the same temperature. Welding can be done in the temperature range **-10°C to +45°C (14°F to +110°F)**.

The power input must be maintained between 230 V ~ ±15% (195,5 V – 264,5 V) at 45 – 65 Hz. To check the input voltage keep the SELECT key pressed down.

If using a site generator the minimum requirement is 4KVA output with 2,5 mm extension leads.

If there is a power outage during welding, you can re-do the welding, but only after the socket has cooled down completely (at least 2 hours). Re-welding may only be attempted once.

For your safety, the welding machine is equipped with an earth fault breaker. For further information about operation and maintenance of the welding machine, see the product manual delivered with the product.



CAUTION: The welding machine may not be used in hazardous areas, including areas where fuel vapors are present.

9.3 Preparations & welding

- Check the products for damage.
- Remove loose dirt with a clean, lint free cloth or paper.
- Make sure that the pipes have been cut squarely.
- Measure the insert depth of the socket. If a steel measure is used, take care not to scratch the inside of the welding socket.
- Mark the insert depth on the pipe/bend/tee/ transition fitting. This is to know the area from which to remove the oxide layer.
- Remove oxide from the areas to be welded, using a scraper. A minimum of 0.1 mm of the surface must be removed over the entire area to be welded + 1 cm extra for easy visual inspection.

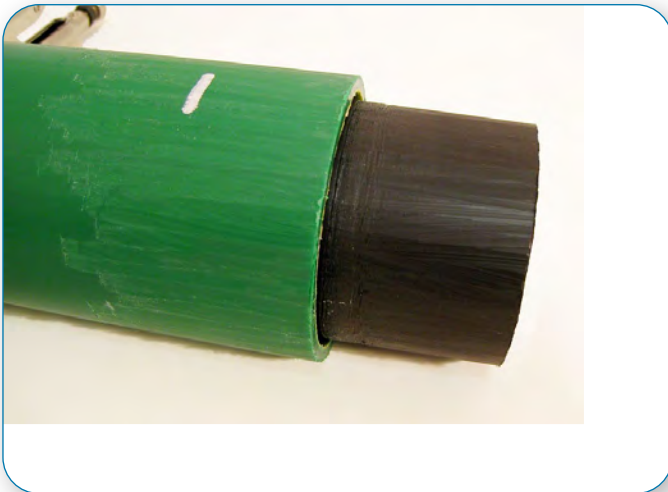

Correctly scraped pipes. Oxide has been removed from the whole area to be welded.



Insufficient scraping. Not all areas have been scraped.

- Re-do the marks for the insert depth on the pipe/ bend/tee/transition fitting as these will be gone after scraping.
- Clean the scraped pipe/bend/tee/transition fitting as well as the inside of the welding socket using acetone or isopropanol and a clean, lint free cloth to remove any grease, moisture or dirt. Do not touch the sockets after cleaning.
- When using conductive pipes, first insert a KP CC (conductive connector) in one of the items to be welded.
- Insert the pipes/bend/tee/transition fitting into the socket, ensure they are pushed completely to the bottom of the socket and properly aligned and fixate them using a fixture or clamping device. Do not clamp too hard or too close to the welding socket as this can make the pipe oval and impair a correct weld.
- Make sure that the parts to be welded are not subject to any tension.
- Check the conductivity.
- Attach the welding cables to the socket and start the welding process.
- After welding is completed, check that the parts have not moved during welding.



NOTICE: If the welding procedure is interrupted, let cool down for at least 2 hours, then check that the pipes are in position before welding again. Re-welding may only be attempted once!

- Mark the socket with "X", date and time and your KPS license number.
- Leave the fixtures on for at least 30 minutes or until the socket has reached body temperature. In warm conditions the cooling times will be considerably longer than 30 minutes.
- Check the conductivity again once the socket has cooled down.

9.4 Welding two single wall pipes

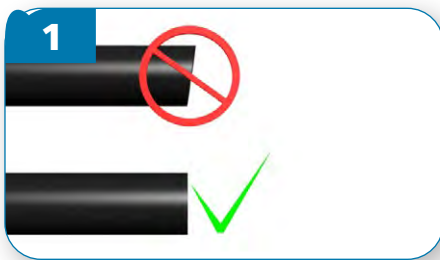

Cut pipes squarely.

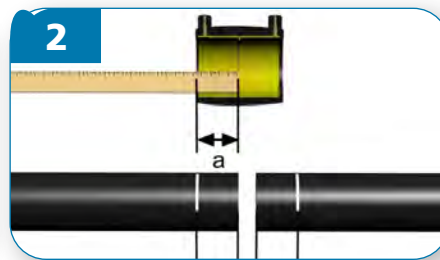

Measure the insert depth and mark the pipes.



Remove the oxide layer and renew the insertion marks.



Clean the area on the pipes that will be welded and the inside of the welding socket with acetone or isopropanol.

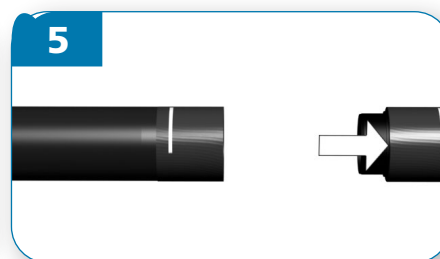

For conductive pipes, insert a KP-CC in the joint.

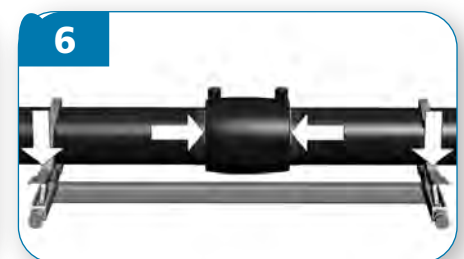

Assemble the joint and lock into place using a clamping tool. Check that the pipes are pushed to the bottom of the welding socket.



Check conductivity.

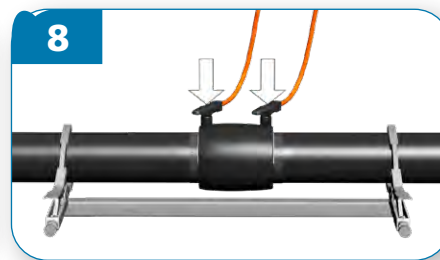

Connect welding cables to the welding socket and follow the welding machine instructions.



Check that the pipes have not moved during welding. Check that welding indicators are out.

Mark the welded socket with "X", date, time and your KPS license number.

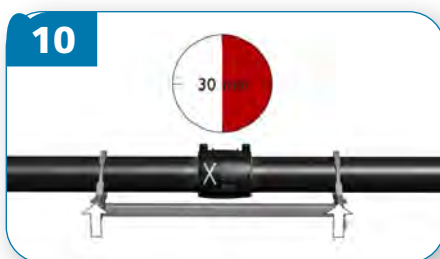

Allow the joint to cool until it has reached body temperature before removing the clamping tool. Minimum cooling time is 30 minutes.

Check conductivity again.

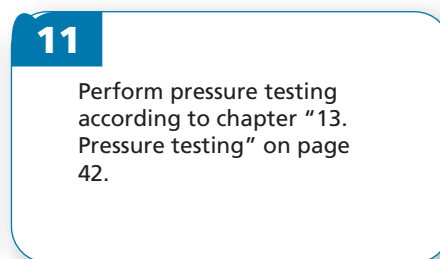

Perform pressure testing according to chapter "13. Pressure testing" on page 42.

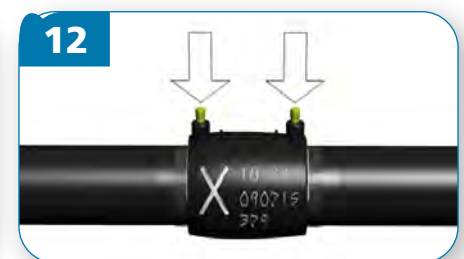

Apply the anti-static caps after pressure testing.

9.5 Welding a single wall pipe & a plastic-to-steel transition fitting

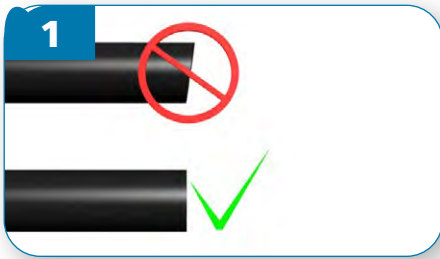

Cut pipes squarely.

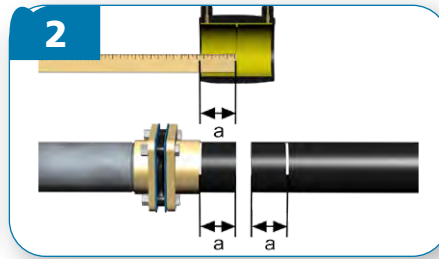

Measure the insert depth and mark the pipe and transition fitting.

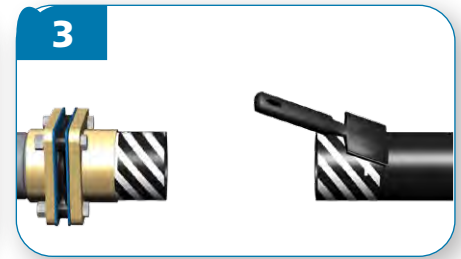

Remove the oxide layer and renew the insertion marks.



Clean the area on the pipe and transition fitting that will be welded and the inside of the welding socket with acetone or isopropanol.

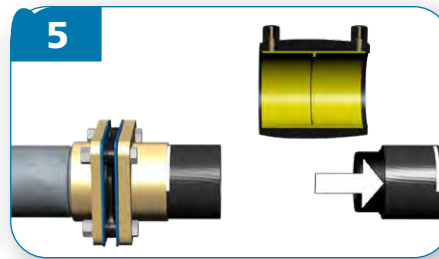

For conductive pipes, insert a KP-CC in the joint.

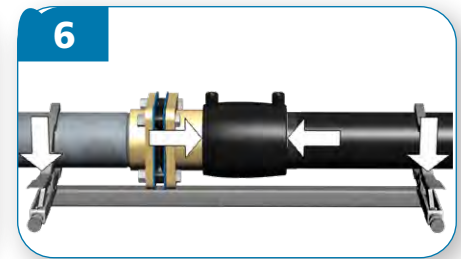

Assemble the joint and lock into place using a clamping tool. Check that the pipe and the transition fitting are pushed to the bottom of the welding socket.

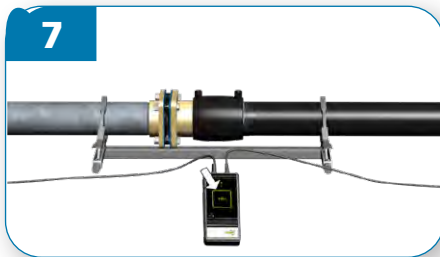

Check conductivity.

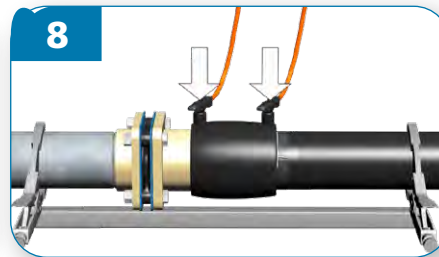

Connect welding cables to the welding socket and follow the welding machine instructions.



Check that the pipe and the transition fitting have not moved during welding. Check that welding indicators are out.

Mark the welded socket with "X", date, time and your KPS license number.

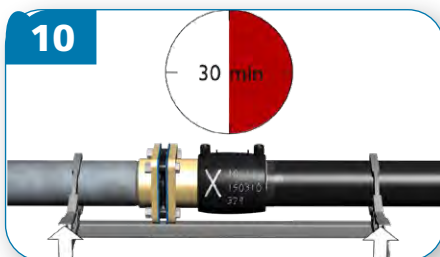

Allow the joint to cool until it has reached body temperature before removing the clamping tool. Minimum cooling time is 30 minutes.

Check conductivity again.

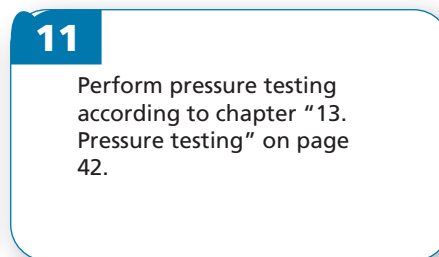

Perform pressure testing according to chapter "13. Pressure testing" on page 42.

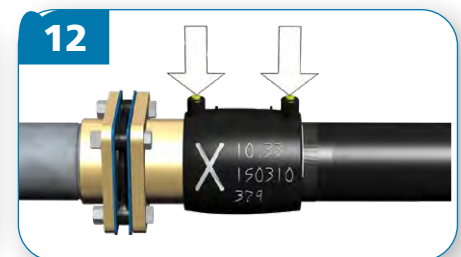

Apply the anti-static caps after pressure testing.

9.6 Welding two double wall pipes with the integrated welding socket KP 2-75/63SC, KP 2-75/63SCA KP 2-125/110SC

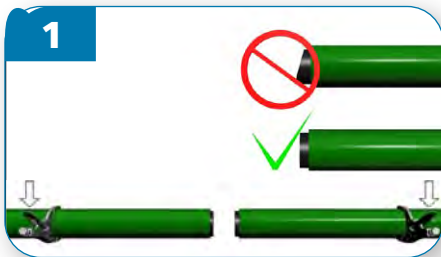

Check that the pipes has been cut squarely and clamp the pipe/bend firmly about 50 cm from the end.

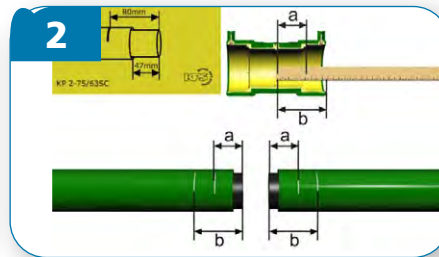

The insert depths are printed on the label of the welding socket. Mark both insert depths.

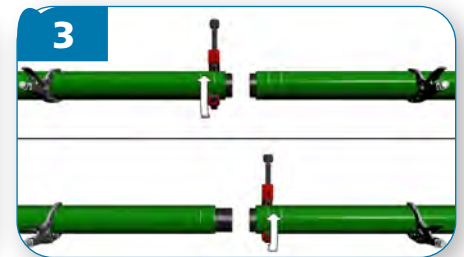

Trim the secondary pipe to match the insert depth.*

* If using straight pipes (not coil) you can also slide the outer pipe to match the inner insert depth and then clamp it firmly before marking the insert depth of the outer pipe. Optionally mark the inner pipe at the opposite end to make sure it is correctly positioned in relation to the outer pipe.



Remove the oxide layer using a scraper from the area to be welded + 1 cm. Renew the insertion marks.



Clean the area on the pipes/bends/tee that will be welded and the inside of the welding socket with acetone or isopropanol.

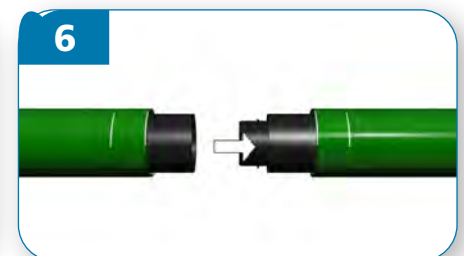

For conductive pipes, insert a KP-CC in the joint.

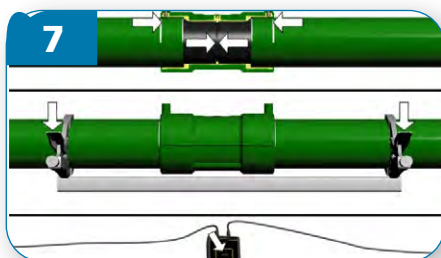

Assemble the joint and lock into place using a clamping tool. Check that the pipes/bends/tee are pushed to the bottom of the welding socket.

Check conductivity.

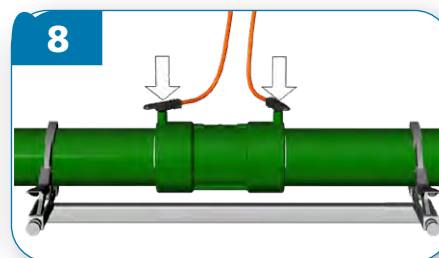

Connect welding cables to the welding socket and follow the welding machine instructions.

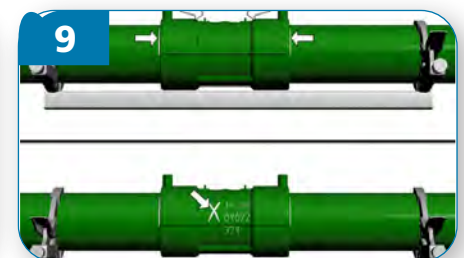

Check that the pipes/bends/tee have not moved during welding. Check that welding indicators are out.

Mark the welded socket with "X", date, time and your KPS license number.

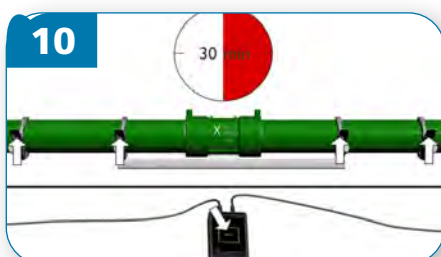

Allow the joint to cool until it has reached body temperature before removing the clamping tool. Minimum cooling time is 30 minutes.

Check conductivity again.

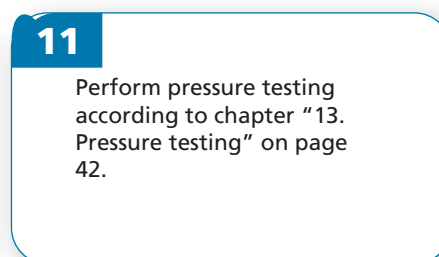

11 Perform pressure testing according to chapter "13. Pressure testing" on page 42.



Apply the anti-static caps after pressure testing.

9.7 Terminating secondary containment no joining

KP T75/635C

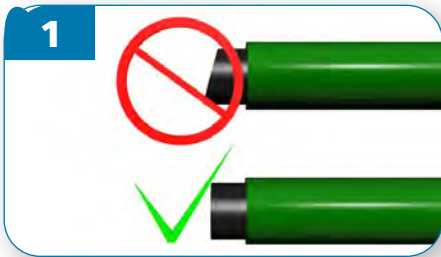

Cut pipes squarely.

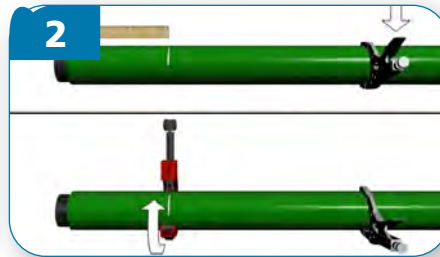

Calculate the length of primary pipe you need for further connections, clamp the pipe firmly about 50 cm in from this point and trim off the outer pipe as required.

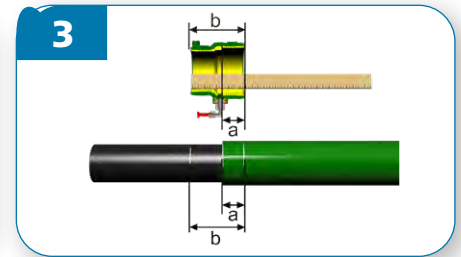

Measure the insert depth of the outer pipe into the termination fitting and the point where the inner pipe will exit the fitting.

Mark the insert depths on the pipes.



Remove the oxide layer and renew the marks on the outer pipes.

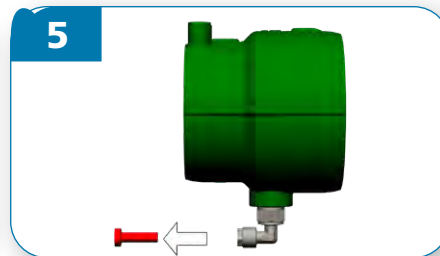

As a precaution, open the test port of the KP T termination fitting to prevent hot air from building up a pressure in the interstitial space during welding.



Clean the areas on the pipes that will be welded and the inside of the termination fitting with acetone or isopropanol.

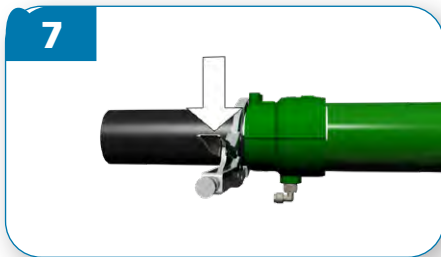

Assemble the KPS termination fitting and lock gently into place using a clamping tool. The pipe **MUST NOT** be oval. The test port of the KP T should be facing down to allow for draining of the interstitial space.

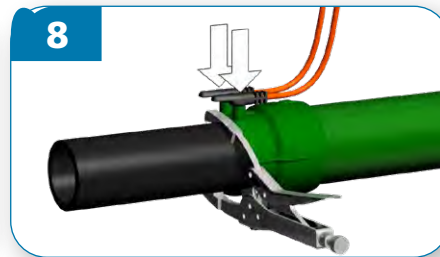

Connect welding cables to the welding socket and follow the welding machine instructions.

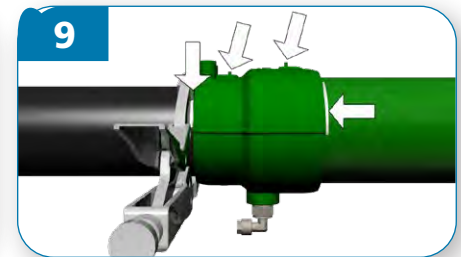

Check that the KPS termination fitting have not moved during welding. Check that the welding indicator is out.

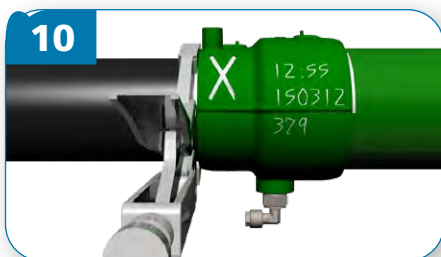

Mark the welded socket with "X", date, time and your KPS license number.

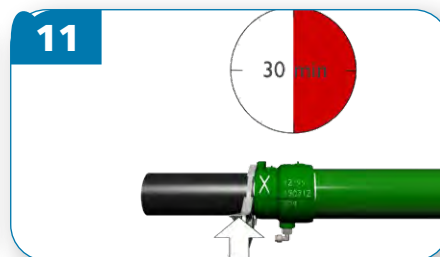

Allow the welding to cool until it has reached body temperature before removing the clamps. Minimum cooling time is 30 minutes.

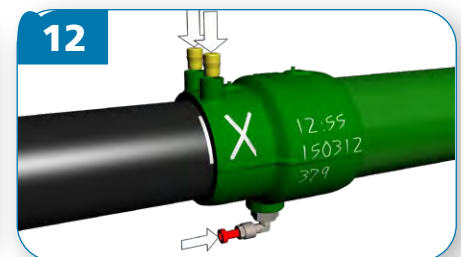

Close the test port and apply the anti-static caps after pressure testing.

9.8 Terminating secondary containment for joining

KP T75/63SC-L, KP T125/110SC

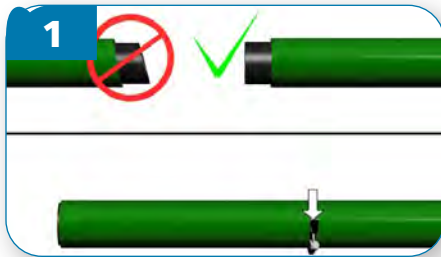

Check that the pipes has been cut squarely and clamp the pipe firmly about 50 cm from the end.

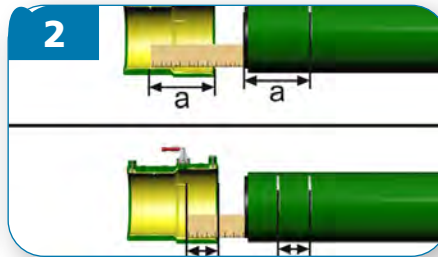

Measure the insert depths of the pipes into the termination fitting.

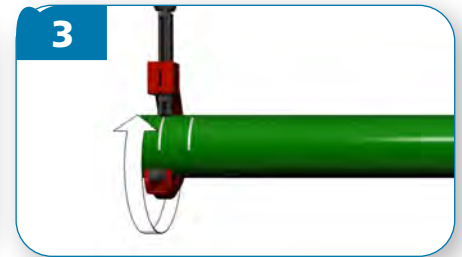

Mark both insert depths and trim the secondary pipe to match the insert depth. *

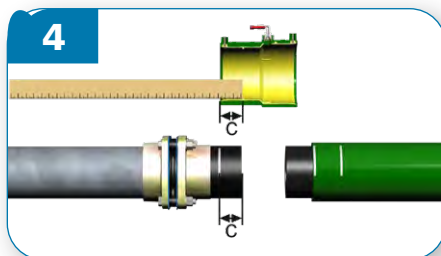

Measure and mark the insert depth of the transition fitting (KP C16 or KP C17) into the termination fitting.

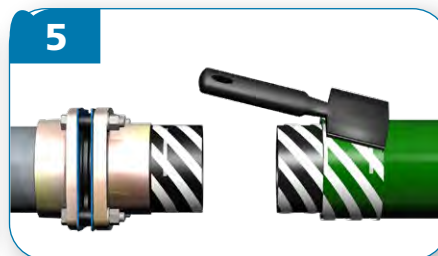

Remove the oxide layer and renew the insertion marks.



As a precaution, open the test port of the KP T termination fitting to prevent hot air from building up a pressure in the interstitial space during welding.

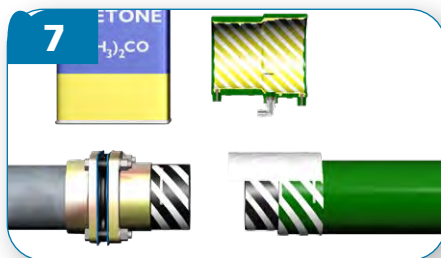

Clean the areas on the pipe/bend and the inside of the termination fitting with acetone or isopropanol.

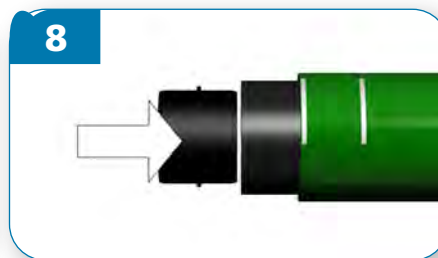

For conductive pipes, insert a KP-CC in the joint.

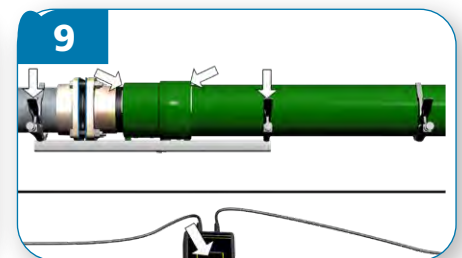

Assemble the joint and lock into place using a clamping tool. Check that the pipe/bend and transition fitting are pushed to the bottom of the termination fitting. The test port of the KP T should be facing down. Check conductivity.

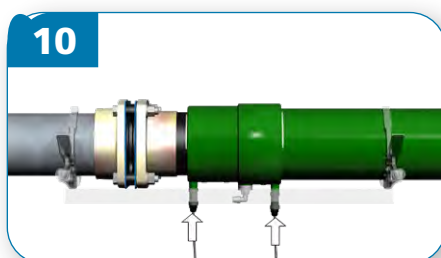

Connect welding cables to the KPS termination fitting and follow the welding machine instructions.

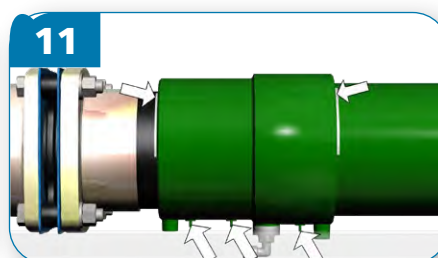

Check that the pipes/bends and transition fitting have not moved during welding. Check that welding indicators are out.

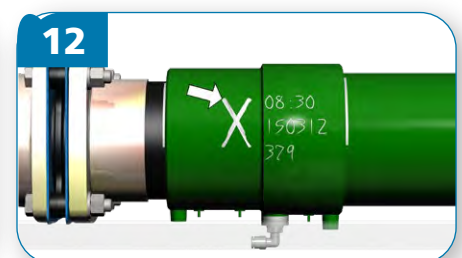

Mark the welded socket with "X", date, time and your KPS license number.

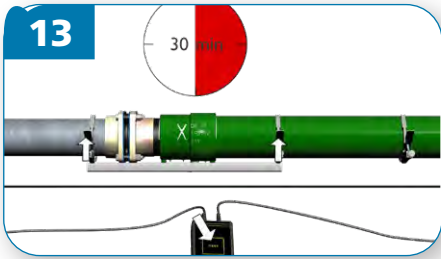

Allow the welding to cool until it has reached body temperature before removing the clamps. Minimum cooling time is 30 minutes.

Check conductivity again.

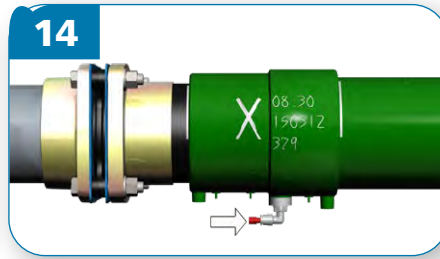

Close the test port.

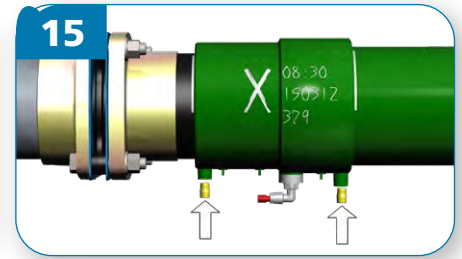

Apply the anti-static caps after pressure testing.

* You can also slide the outer pipe to match the inner insert depth and then clamp it firmly before marking the insert depth of the outer pipe. Optionally mark the inner pipe at the opposite end to make sure it is correctly positioned in relation to the outer pipe.



NOTICE: Only pneumatic plastic tubing made from polyamide 11 or 12 should be connected to the test ports of KP T fittings. To connect to leak detection systems that use metal pipes, mount metal connections on the sump wall and then connect them with pneumatic tubes to the test ports of the KP Ts.

9.9 Termination fittings without test port (KP T black)

The black termination fittings are designed for use outside of sumps, when direct burial is required. KP Ts with a test port should not be buried in the ground because of the risk of mechanical damage to the test port and subsequent potential leakage. Check continuous flow before applying and welding the black KPS.

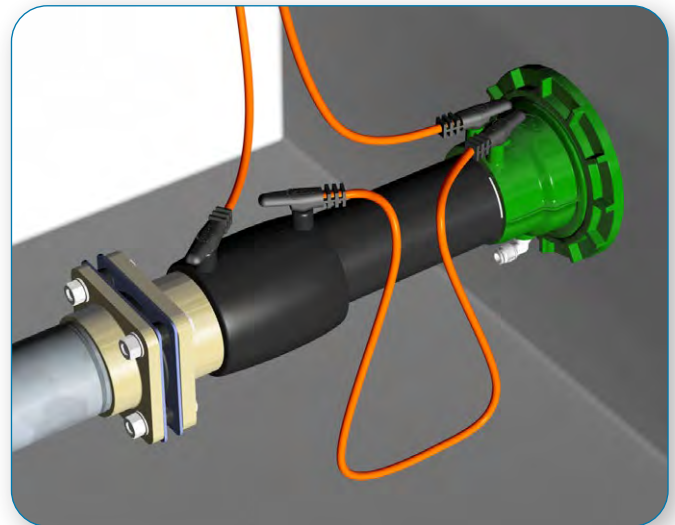

Welding in series.

Welding fittings in series

Some combinations of KPS welding sockets may be welded simultaneously using the jumper cable KP 10804 (orange) for 2 mm welding pins included with the KP 108B welding machine. To weld in series, connect one welding cable to each socket and connect the sockets with the jumper cable.

Only some combinations of welding sockets can be welded in series. Welding in series can be carried out if the circled number on welding sockets adds up to 10 or less. If the sum is greater than 10, welding in series cannot be carried out. If there are no numbers on the sockets, welding in series must not be used.



$$4 + 4 = 8$$

Serial welding can be done.



$$4 + 4 = 8$$

Serial welding can be done.



$$6 + 4 = 10$$

Serial welding can be done.



$$6 + 6 = 12$$

No serial welding.

10. Entry seals

10.1 General

Your choice of entry seal should be based on the type of pipe and the type of tank chamber/dispenser used. The integrated entry seal and termination fitting should always be the first choice for double wall pipes as it provides a compact and sturdy solution. All entry seals must be mounted on a flat chamber wall with the pipe entering at a straight 90° angle.

10.2 Integrated entry seal & termination fitting

KP TM75/63SC

This entry seal is made for double wall pipe Ø75/63 mm. The short and compact design makes it useful in confined spaces inside tank chambers, dispenser chambers etc.

KP TM75/63SC-L

This entry seal is made for double wall pipe Ø75/63 mm and it can be joined inside directly with a transition fitting. Saves one welding socket + space.

KP TM125/110SC

This entry seal is made for double wall pipe Ø125/110 mm and it can be joined inside directly with a transition fitting.



KP TM75/63SC

KP TM75/63SC-L

KP TM125/110SC

10.3 Rubber boot entry seal

The rubber boot entry seal are designed for use with single wall pipes. If you want to use that entry seal with double wall pipes it must be used in combination with a KP T termination fitting.

KP TM32/15, entry seal for pipe Ø32, 20 and 15 mm or cables.

KP TM125/90, entry seal for pipe Ø125, 110 and 90 mm.

KP TM75/54, entry seal for pipe Ø 75, 63 and 54 mm or cables

KP M75/54, entry seal for pipe Ø54, 63, 75

KP M160/90, entry seal for pipe Ø90, 110, 125, 160



KP TM32/15



KP TM125/90



KP TM75/54



KP M75/54

NOTICE: The rubber boots must never be used for termination of the interstitial space.

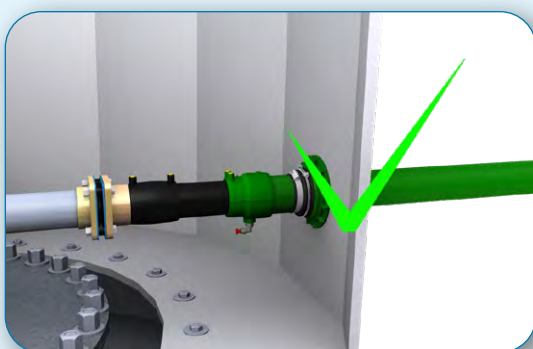

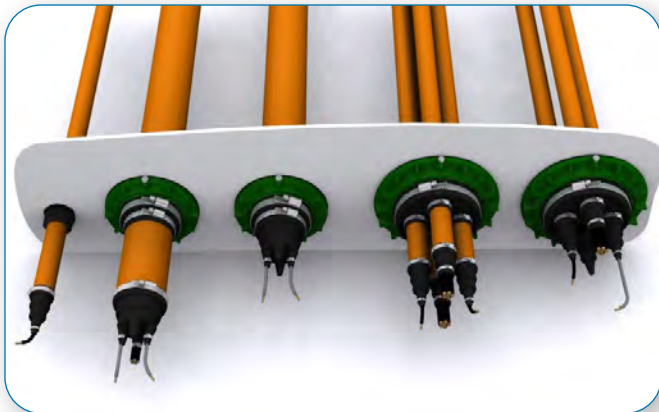

Different uses of KPS entry seals for electrical conduits.

10.4 Installation in tank

1. Use the KPS laser pointer (KP LP01) to position the entry seals correctly:
 - Place the laser pointer in the transition fitting and press the button.
 - Make a mark at the point where the laser beam hits the chamber wall.
 - Drill a small hole from the inside at the mark.
 - Move to the outside of the chamber, where you have more space and use a hole saw to drill the hole for the entry seal. Use a hole saw of diameter 114 mm (4 1/2") or 168 mm (6 5/8") depending on the size of the entry seal.
2. Install the entry seal according to instructions.
3. Fit the KPS pipe through the entry seal and weld it to the transition fitting. Make sure the pipes are clamped during welding and that no stress is put on the pipes or socket during welding. Make sure the pipes are supported inside and outside of the chamber during welding. Allow to cool until the weld has reached body temperature.



Use the KP LP01 laser pointer to position the entry seal correctly.

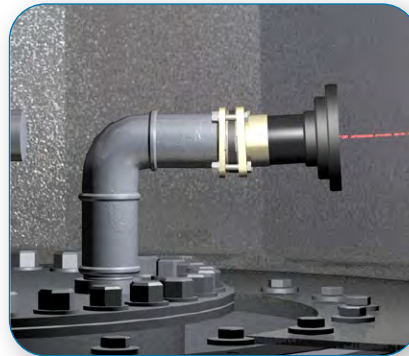

Place the laser pointer in the pre-mounted fittings on the manway lid.



Make sure the pipes are in a straight angle to the chamber wall and fittings on the manway lid.



NOTICE: Installation of transition fittings should be stress-free and have an entry angle of 90°. Make sure the pipes outside chambers are well supported.



Warning! Do not stare into beam.

10.5 Installing threaded entry seals

KP TM32/15, KP TM75/54 & KP TM125/90

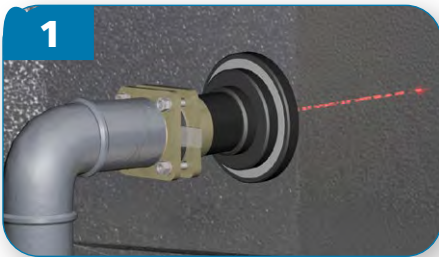

Use the KP LP01 laser pointer to position the entry seal correctly.

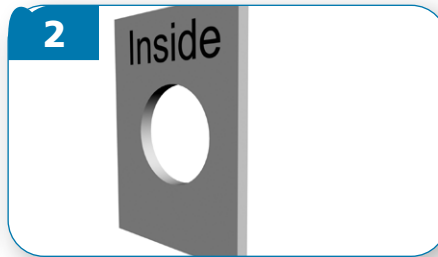

Drill the hole.
KP TM75/54 = Ø114 mm
KP TM32/15, 125/90 = Ø168 mm

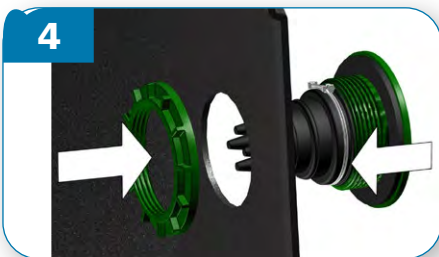
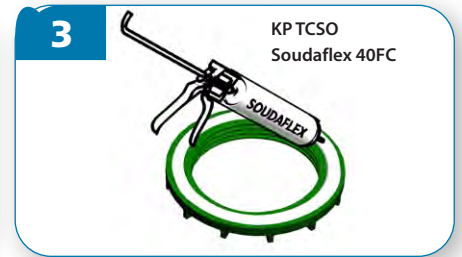

Mount the entry seal from outside with the nut on the inside of the chamber.

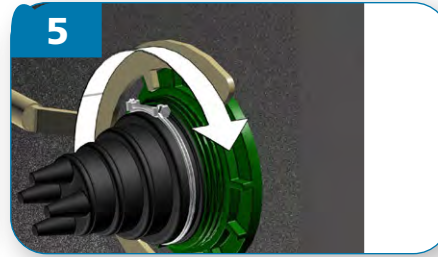

Tighten the nut with the entry seal tool (KP TMS) until the gasket is compressed to about 50% of original thickness.

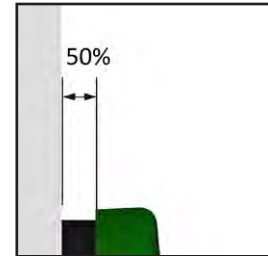

Cut the rubber boot seal to fit the pipe. Lubricate the pipe if necessary.

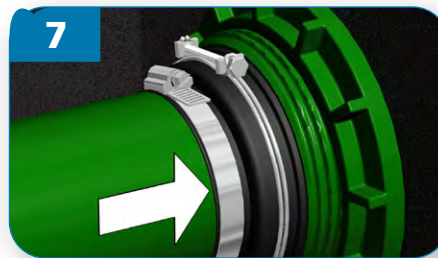

Fit the pipe through the entry seal and jubilee clip, and make necessary connections inside the chamber.



Lubricate the outside of the rubber boot before tightening the jubilee clips around the rubber boot.

10.6 Installing integrated entry seals & termination fittings

KP TM75/63SC, KP TM125/110SC

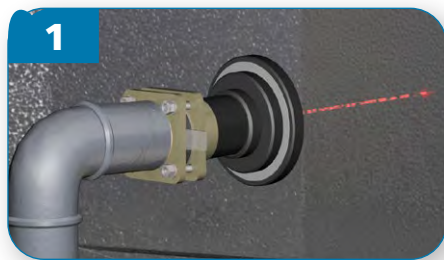

Use the KP LP01 laser pointer to position the entry seal correctly.



Drill the hole.
KP TM75/54 = $\varnothing 114$ mm
KP TM32/15, 125/90 = $\varnothing 168$ mm

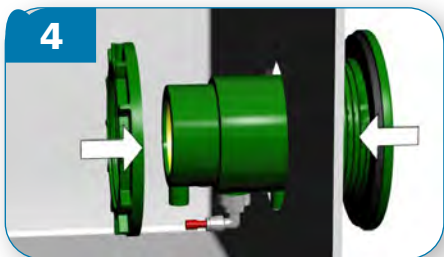
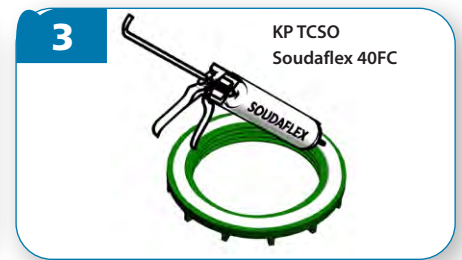

Mount the entry seal from outside with the nut on the inside of the chamber. The test port must be removed before the nut can be mounted. The test port should be facing downwards.

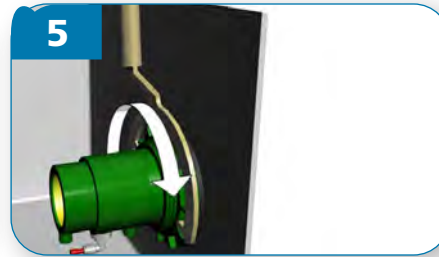

Tighten the nut with the entry seal tool (KP TMS) until the gasket is compressed to about 50% of its original thickness.

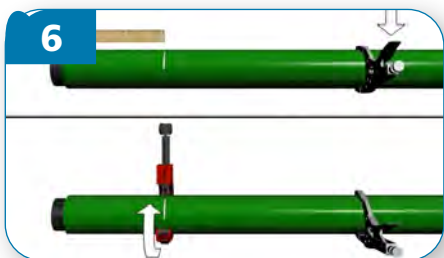
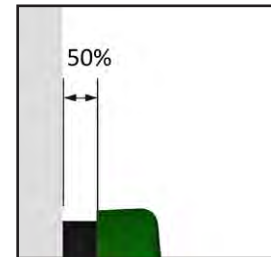

Clamp the inner and outer pipe firmly using a clamping tool, about 50 cm from where you want to cut it.

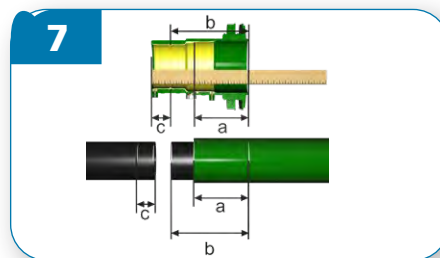

Trim the inner and outer pipe to the desired length and to match the insert depth of the KP TM fitting.

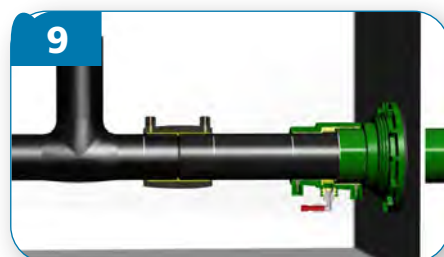
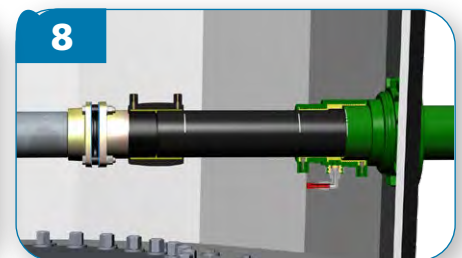

When installing 75/63 mm pipes the inner pipe should continue through the fitting, all the way to where it is connected with the plastic-to-steel transition fitting in tank chambers or with a bend or tee in a dispenser chamber.

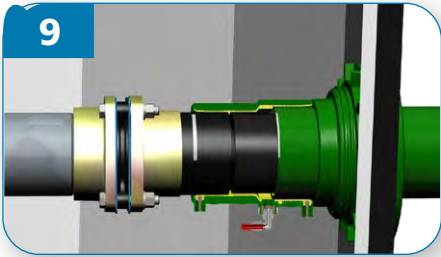

9 A 125/110 mm pipe will end inside the KP TM fitting where it can be joined directly with a transition fitting or a single wall pipe.



10 Mark and scrape all areas of the pipe that will be welded + 1 cm extra.



11 Clean the scraped areas of the pipe and the inside of the fitting with acetone.

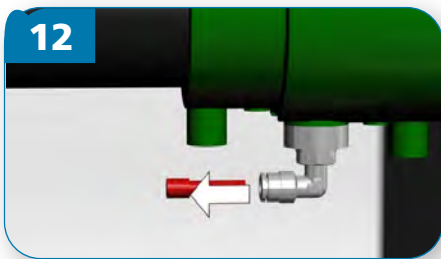

12 Open the test port to prevent hot air from building up a pressure in the interstitial space during welding.

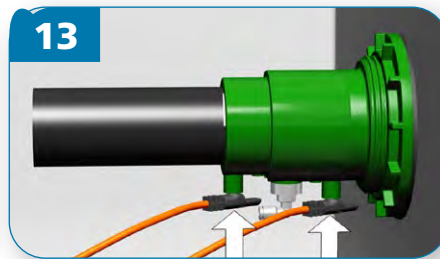

13 Make sure the pipes and fittings are clamped in position, well supported and not subject to stress of any kind.

Weld the termination fitting.

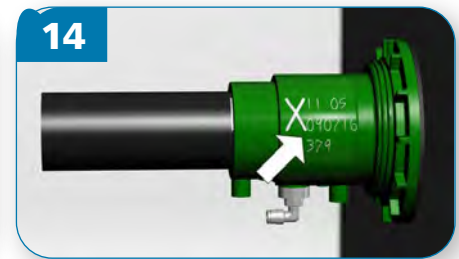

14 Mark the fitting with an X, date, time and your KPS certification number.

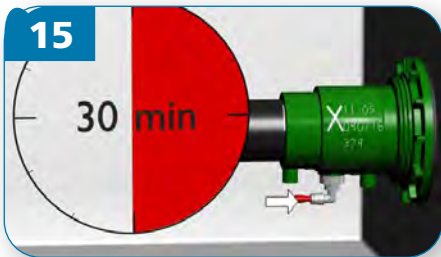

15 Allow the entry seal to cool down before doing any other work. Close the test port.

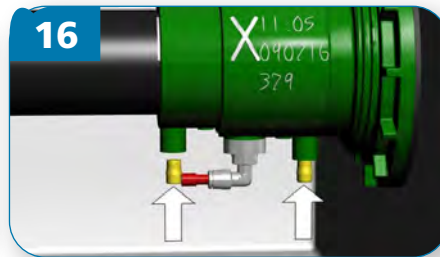

16 Apply the anti-static caps after pressure and tightness test.

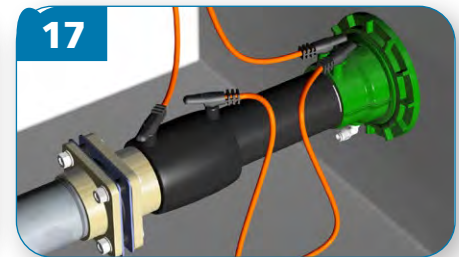

17 The KP TM75/63SC can be welded at the same time as a KP 2-63 welding socket when connected with the jumper cable supplied with the KP 108B welding machine. This must **NOT** be done with the KP TM125/1105C.

10.7 Installing integrated entry seal & termination fitting

KP TM75/63SC-L

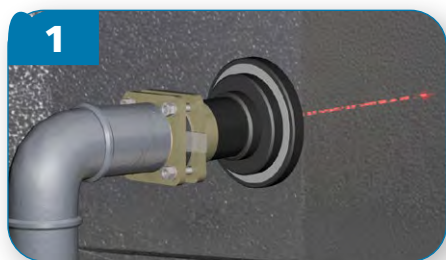

Use the KP LP01 laser pointer to position the entry seal correctly.



Drill the hole.
KP TM75/63 = $\varnothing 114$ mm.

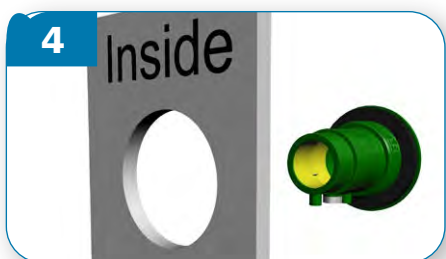
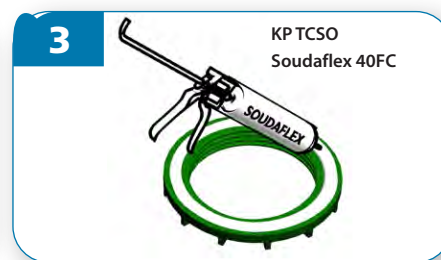

Mount the entry seal from outside with the nut on the inside of the chamber. The test port must be removed before the nut can be mounted. The test port should be facing downwards.

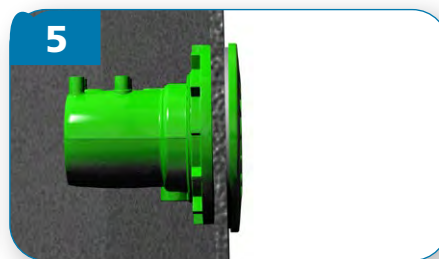

Mount the nut from the inside of the chamber.

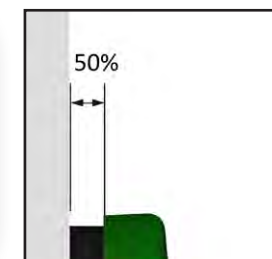

Tighten the nut until the gasket is compressed to about 50% of its original thickness.

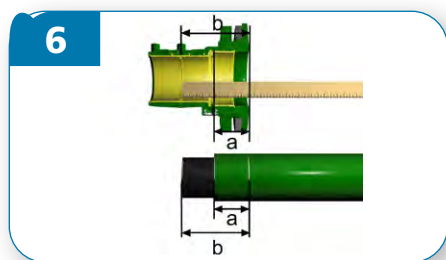

Measure and mark the insert depths for inner and outer pipe.



Remove the oxide layer from welding area using a scraper.



Clean the scraped areas on the pipe, and inside of the termination fitting with acetone or isopropanol.

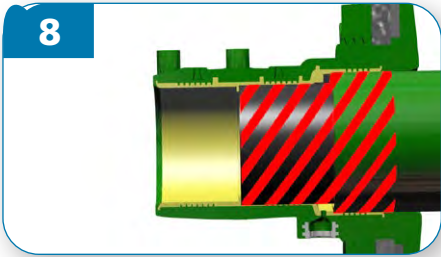

8 When welding the double wall pipe, the inner welding towers should be used.

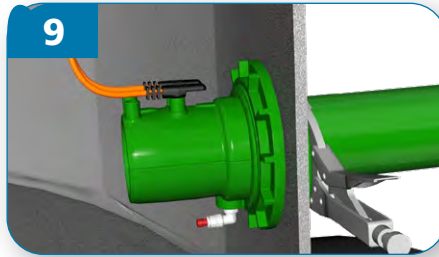

9 Mount and make sure the pipes are in position. Connect the welding cables and follow the welding machine instructions.

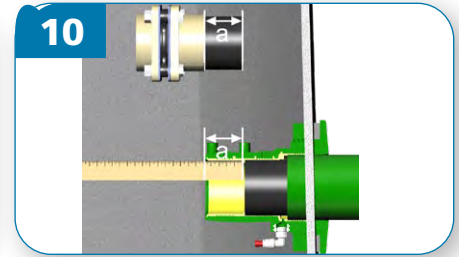

10 Measure the insert depth and mark it on the transition fitting.



11 Remove the oxide layer from welding area using a scraper.



12 Clean the scraped area on the transition fitting and inside of the termination fitting with acetone or isopropanol.

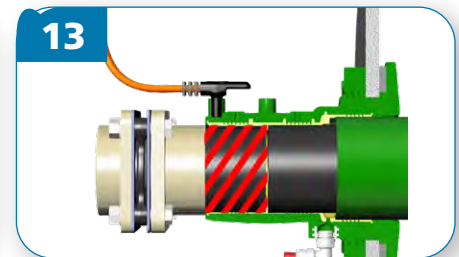

13 When welding the fitting, the outer welding towers should be used. Add a KP CC in the joint.

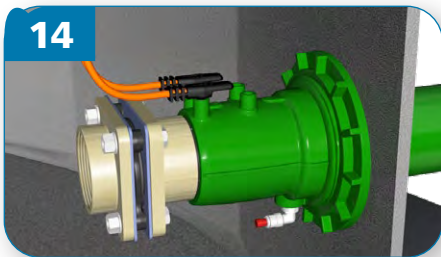

14 Mount the fitting, connect the welding cables and weld.

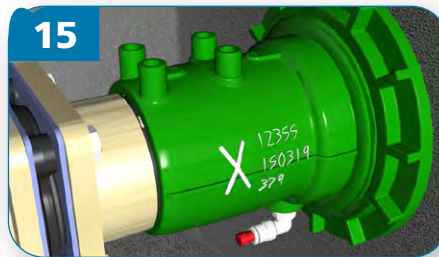

15 Mark with an "X", date, time and your KPS certification number.

10.8 Installing entry seal

KP M75/54, KP M160/90

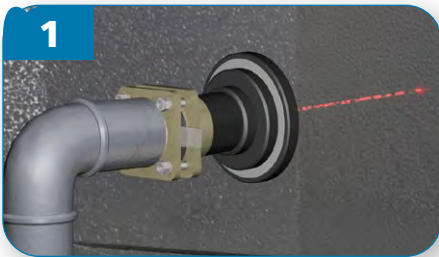

Use the KP LP01 laser pointer to position the entry seal correctly.

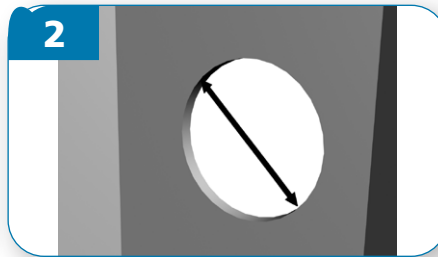

Drill the hole.
KP M75/54 = Ø92mm
KP M160/90 = Ø140mm

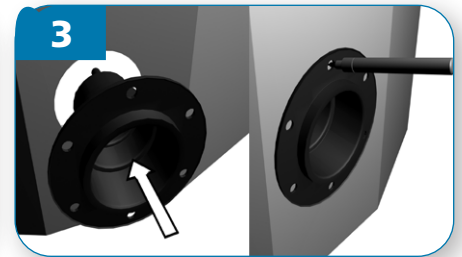

Place the rubber boot in the hole, make a mark in the small holes for the screws



Drill the holes.



Use Soudaflex 40FC for sealing.

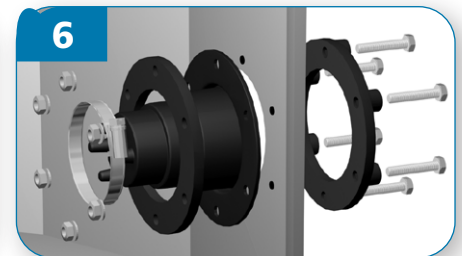

Mount the entry seal.

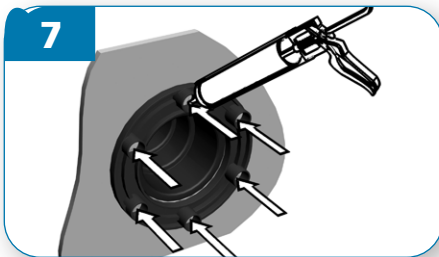

Fill the holes from outside.



Mount the end caps.

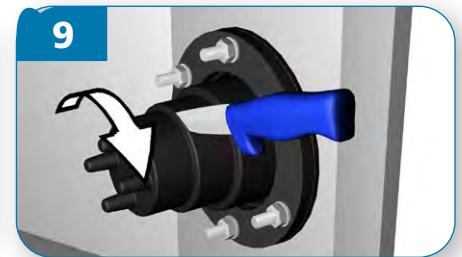

Cut the rubber boot seal to fit the pipe. Lubricate the inside of the rubber boot with soap water to more easily fit the pipe through the boot.

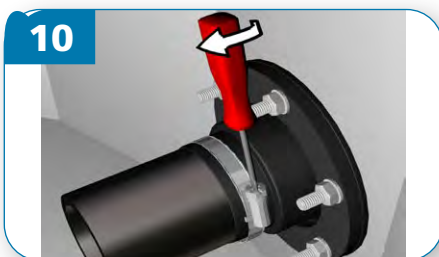

Fit the pipe through the entry seal and jubilee clip. Make necessary connections inside the chamber, and tighten.

11. Connecting the end points

11.1 The plastic-to-steel transition fittings

Flange fitting, KP C16

The KP C16 should be used wherever lines may need to be disconnected for maintenance or inspection. A spacer between the flanges is the default as it can be removed to give room for a blank flange for blank-off or pressure testing or just for easier access to the tank lid.

Before welding, remove oxide from the plastic part of the KP C16 using a scraper and mark the insert depth. Follow KPS instructions for welding, preparation and cooling. For conductive pipes, insert a KP CC in the joint.

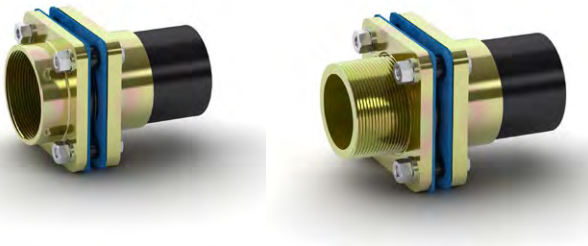

Flange fitting, KP C20

The KP C20 is an alternative to KP C16 where a DIN flange connection is desired.

Before welding, remove oxide from the plastic part of the KP C16 using a scraper and mark the insert depth. Follow KPS instructions for welding, preparation and cooling. For conductive pipes, insert a KP CC in the joint.

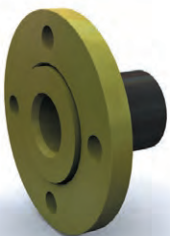

Threaded fitting, KP C17

The KP C17 is mainly used under ventilation stacks or filling points where it is placed vertically just below ground level, or as a transition fitting under dispensers.

A KP 2 welding socket should be used to join the fitting with the plastic pipe, except for in double wall systems where the KP C17 fittings of diameter 110 mm can be welded directly with a KP T125/110SC termination fitting.

Before welding, remove oxide from the plastic part of the KP C17 using a scraper and mark the insert depth as measured from the chamfered metal edge. Follow KPS instructions for welding, preparation and cooling. For conductive pipes, insert a KP CC in the joint.

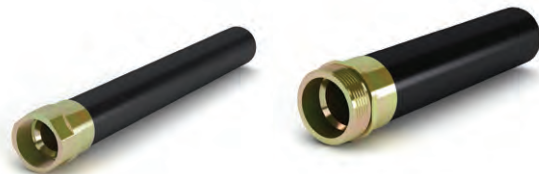

Compression fitting, KP C14

The KP C14 transition fitting is mainly used in dispenser chambers both for product lines and vapor recovery lines. This fitting provides a compact solution as it does not require the use of a KP 2 welding socket but is used directly with the pipe, bend or tee. Installation instructions for the KP C14 are enclosed with the product.



11.2 Tank lid connections

Connection of pipes to the tank lid should always be made with consideration to future inspection and maintenance needs.

Where there is no separate manway lid it is absolutely necessary that the tank lid can be removed for inspection of the tank. A flange fitting should be used for the plastic-to-steel transition and mounted in a way that simplifies removal of the tank lid.

Shut-off valves may be installed on product lines to enable easy isolation of a pipe in case of maintenance, repair and upgrades.



Tank lid connections with flange fittings and shut-off valves.

11.3 Dispenser connection

The risers for product and vapor recovery should be flexible, either plastic or flexible steel hoses should be used. Rigid risers should never be used as they do not absorb forces that can damage valves and dispenser connections.

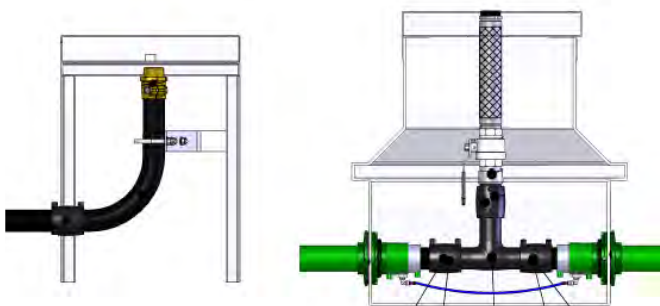

A plastic bend in a suction system and a flexible connector in a pressure system.



NOTICE: Installation of transition fittings should be stress-free and have an entry angle of 90°. Make sure the pipes outside chambers are well supported.

11.4 Filling point

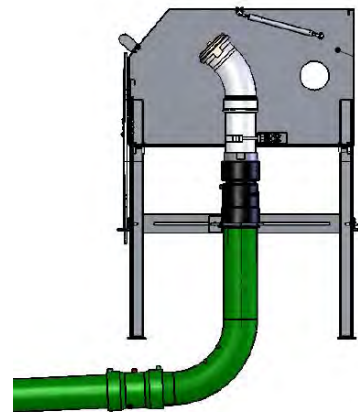

Example of a good filling point installation.

The transition from plastic to steel under the fill box should be done vertically, at ground level. The best flow characteristics are achieved when formed plastic bends are used. Elbows can be used when a vertically compact solution is necessary. Both alternatives provide flexibility that helps the piping system cope with thermal expansion and ground movement.

A black KP T without test port and a threaded transition fitting, installed vertically, is a good solution for termination of secondary containment and plastic-to-steel transition.

Ensure that traffic barriers are installed to protect the fill lines from damage.

11.5 Ventilation stack connection



The ventilation stack should be installed in its correct position and secured before the pipe installation begins. The ventilation pipes will need proper support to ensure they do not tip over.

The transition from plastic to steel under the ventilation stack should be done vertically. Plastic formed bends or weldable elbows can be used to go from horizontal to vertical. Both alternatives provide flexibility that helps the piping system cope with thermal expansion and ground movement. A threaded transition fitting is an appropriate choice for plastic-to-steel transition at the ventilation stack.

Ensure that traffic barriers are installed to protect the ventilation pipes from damage.

12. Earthing and static electricity

12.1 Installing conductive pipes

The installation of KPS conductive pipes is similar to the installation of KPS non-conductive pipes and the same tools and equipment can be used.

In addition you will need:

- KP CC conductive connectors to be used in every joint.
- KPS conductivity tester.

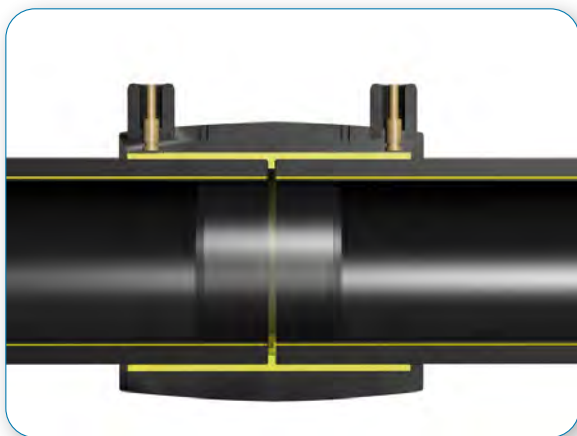

Conductive connectors should be inserted in every joint.

Using the conductivity tester

Calibrate the tester at the beginning and end of each work day. Test both the red and the green signal according to the picture.

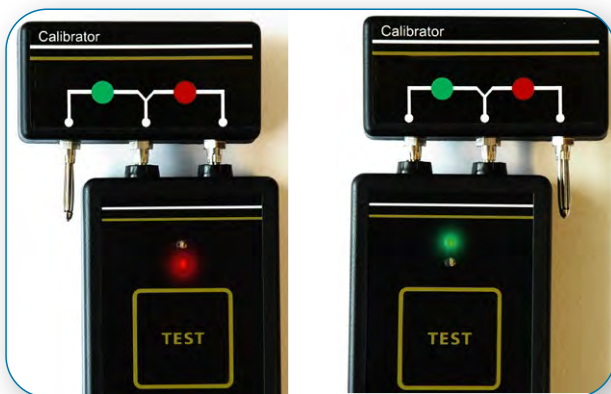

Calibrate the conductivity tester at the beginning and the end of the day.

1. Connect the cables to the tester and to the ends of the pipe run.
2. Press the "TEST" button. A green light and a beep indicate OK. A red light and no beep indicate not OK.

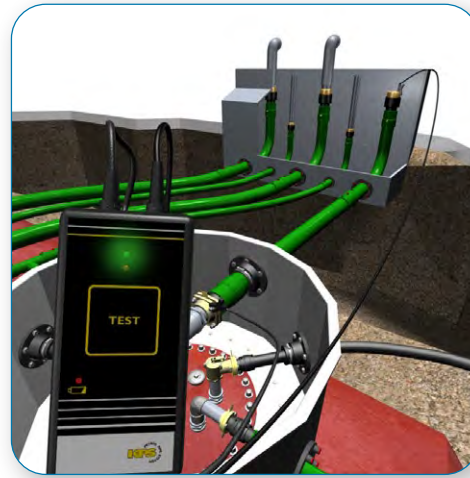

When the battery indicator light turns red, replace the 9V battery.

Test each joint

Test the conductivity before each welding. If a KP CC is missing it can easily be inserted at this point. Test the conductivity again after welding to make sure all is OK.

Test the completed pipe run

When testing the completed pipe run, make sure that the test current cannot find an alternate route, for example via the ground between the tank and fill point:

- Do not connect both ends of the pipe run to steel to prevent the test current from finding an alternative route



- Test the conductivity of the pipe run from the starting point to the end point.
- Weld the transition fitting, allow too cool and re-test before connecting to metal.

Connect the piping system to earth and provide bonding

The conductive piping system must be connected to earth. Bonding and earthing of adjacent conductive objects is necessary only if it is required by applicable regulations and legislation.

Always consult a competent electrical engineer, familiar with national regulations, to make sure that earthing and potential equalization of the piping system and adjacent installations are done in a correct way to prevent electrostatic hazards.

12.2 Installing non-conductive systems

Non-conductive systems shall be avoided when possible, and only installed on specific customer instructions.

Installing non-conductive systems is more complicated than installing conductive systems. When non-conductive pipes are used, extra safety measures must be taken to minimize electrostatic hazards.

To lower the risk of fires or explosions due to static electricity:

1. Identify areas where a potentially explosive atmosphere can be present, even for shorter periods.
2. Connect all conductive parts of the piping system and other conductive objects in the proximity to earth:



- Bond all exposed metal parts of fittings, flanges, jubilee clips and other conductive objects in chambers and at fill points, and connect to earth.
- Welding socket pins must be sealed with plastic plugs.
- Check the earthing of all conductive components using an insulation meter.
- Personnel should take special precautions and avoid becoming electrostatically charged.

3. Avoid unburied piping and do not admit fuel into a pipe before backfill. Exposure of pipes and joints in chambers should be minimized.
4. Equipment such as fine filters (e.g flame arrestors) may give enhanced fuel charging and should be used only after careful assessment of likely hazards.
5. Ensure dielectric properties – i.e. sufficient pipe wall thickness (polyethylene pipes) or electrical breakthrough strength of at least 100kV.
6. Avoid potentially hazardous liquid impurities and compositions.
7. Keep fuel flow below 2.8 m/s and for high charging biofuels to even less.
8. Minimize the number of hazardous designs, routines and human errors through strict guidelines, education and training of all relevant parties.
9. Check all earthing arrangements regularly.

In any case of uncertainty, consult a specialist. Make sure to follow national regulations.

These and other necessary measures are specified in the IEC standard IEC 60079-32-1, section 7.8.4.



CAUTION: The bonding and earthing arrangements in non-conductive systems must be inspected and tested at regular intervals and whenever work, inspection and maintenance has taken place. There is a considerable risk that earthing wires loose contact due to snagging or oxidation.

Inspection, re-testing & recurring testing

The bonding and earthing arrangements in non-conductive systems must be inspected and tested at regular intervals and whenever work, inspection and maintenance has taken place.

The following checks need to be made in all tank chambers, dispenser chambers and fill boxes.

- Check that all otherwise isolated conductive objects are bonded and connected to earth and that welding socket wiring is capped properly.
- Make a visual inspection to check for corrosion and loose or loosening earthing wires.
- Measure using an ohmmeter from each conductive object to the earthing point to verify earthing.

13. Pressure testing

Correctly performed pressure and tightness tests are essential to ensure the quality of the installation and problem-free operation.

All pressure and tightness testing must comply with local, national or regional rules and regulations.

The pressures and test times specified here are the minimum requirements for a valid KPS warranty. Local, national or regional rules and regulations may require stricter testing to be performed. Special accreditations or permits may be required for pressure testing with gases at high pressures.



SAFETY: When fuel has been present in any part of the system to be tested, nitrogen must be used for testing. Ensure that all pipes have been thoroughly flushed from fuel and fuel vapors using nitrogen before commencing any work.

Before applying pressure to the system, make a risk assessment and ensure that all personnel keep a secure distance to the system when it is under pressure. All national, regional and local safety regulations must be adhered to.

EQUIPMENT:

- Equipment to blank off the pipe run in both ends.
- Metal flanges or plugs with test ports (for test of the primary pipe).
- Compressed air or nitrogen.
- 6 mm tube of PA (polyamide) 11 or 12. Tube must be cut squarely using appropriate cutting tools. Look out for wear where the tube is connected to pressure gauge or test ports.
- Soap solution, made from water and a bit of detergent, such as soap, washing-up liquid or similar. Put in a spray bottle for easy application or use sponge and a bucket.
- Pressure gauges. The scale of the gauges should show the pressure used for testing in the middle of the scale.
- Mirror.

13.1 Pipe strength pressure test - Before backfill (mandatory)

Objective	Containment	Test method	Verification
Finding potentially weak parts in the system.	Primary pipe	5 bar (72.5 psi) for 5 minutes.	No parts should come loose.
	Secondary pipe	1 bar (14.5 psi) for 5 minutes.	

It is mandatory when installing KPS pipes in a pressure system to perform a pressure test of the completed piping. Both the primary and the secondary pipe must be tested with the objective of finding any potentially weak points in the installation.

Procedure

Primary pipe

- Record temperature and pressure at start of testing
- Pressurize with air or nitrogen successively up to test pressure: **5 bar for primary pipe**
- Hold the test pressure for 5 minutes
- Record temperature and pressure at end of testing
- Record duration of test

Secondary pipe

- Record temperature and pressure at start of testing
- Pressurize with air or nitrogen successively up to test pressure: **1 bar for secondary pipe**
- Hold the test pressure for 5 minutes
- Record temperature and pressure at end of testing
- Record duration of test

If correctly installed no parts should come loose. Always blank off the pipe run to be tested from the tank and from the dispenser. Any testing of the tank or the connection of the pipes to the tank must be done in a separate step.

Pipes in a suction system are not subject to continuous operating pressure and the hammer effects in a suction system are less prominent. For these reasons pipes in a suction system only need to be tested for tightness, using a lower pressure. Pressure testing of suction systems are not mandatory, but can be performed as an extra security measure.



NOTICE:

NOTE 1: Under no circumstances should the pressure in the secondary containment exceed the pressure in the primary containment with more than 1.0 bar.

NOTE 2: Do not perform this test if the pipe surface temperature exceeds 70°C, which can occur when site ambient temperature is above 35°C and the pipe is exposed to direct sunlight.

13.2 Pipe tightness test - Before backfill (mandatory)

Objective	Test method	Verification
Finding any leaks in the system.	0.02-0.70 bar (0.3-10 psi) for 1 hour. Adapt the pressure to the resolution of the manometers used.	Bubbles indicate leakage.
	Soaping of all joints.	Declining pressure that cannot be explained by a temperature drop indicates leakage.
	Document pressure and temperature during test period every 10 minutes.	

It is mandatory with both pressure and suction systems to test the tightness of the completed piping. Both the primary and the secondary pipe must be tested to ensure that there are no leaks in the system.

The tightness of a piping system before backfill is validated by:

1. Soaping all joints when the pipe is pressurized. Bubbles indicate leakage.
2. Reading any pressure and temperature variations during a test period. A declining pressure indicates leakage.

Tip: Soaping is the best method for locating a leak



The formation of bubbles is a sure indication of leakage.

Procedure

- Pressurize the pipe with air or nitrogen to a pressure of 0.02 to 0.70 bar (0.3-10 psi). Adapt the test pressure to the resolution of the pressure gauges used so that variations in pressure can be read easily. Vacuum (negative pressure) must not be used.
- Document the starting pressure.
- Apply soap solution to all joints (starting with the test equipment and its connections) and look for bubbles that indicate leakage. Pay attention to the soaping under the pipes and if necessary use a mirror for a clear view of the bottom of the pipes.
- Document the pressure and ambient temperature at 10 minute intervals for a period of 1 hour. There should be no pressure variations that do not have a reasonable explanation in recorded temperature variations.

If using a less accurate pressure gauge, prolong the test period to 4-24 hours.

Guidelines for judging pressure variations during tightness testing

All pressure variations should have a reasonable explanation in documented temperature variations. The pressure of the gas used for tightness testing increases and decreases with the temperature.

1.

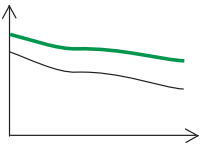

Temperature and pressure as a function of time. Green curve = pressure. Black curve = temperature.

Scenario 1

Over the test period the pressure has varied and dropped some, but the temperature shows very similar changes. Unless any leaks were identified during soaping, the system is likely to be tight.

2.

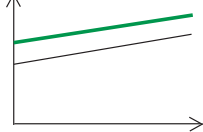

Temperature and pressure as a function of time. Green curve = pressure. Black curve = temperature.

Scenario 2

Over the test period the pressure has increased some. This is explained by the increase in ambient temperature recorded during the same period. Unless any leaks were identified during soaping, the system is likely to be tight.

3.

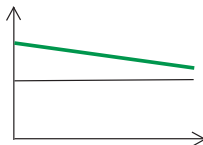

Temperature and pressure as a function of time. Green curve = pressure. Black curve = temperature.

Scenario 3

The temperature has kept quite still during the test period, but the pressure dropped slightly. This is very likely due to a leak. Identify the place of the leak by soaping.

13.3 Testing double-walled pipes

When testing the primary pipe in a double wall pipe run, make sure that the test port of at least one KP T fitting is open.

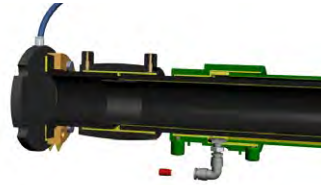

When testing the secondary pipe:

Make sure that the primary pipe is open in at least one end.

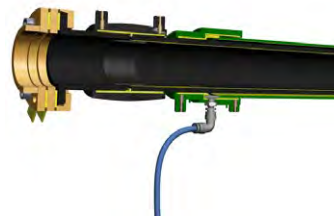

- Check that the interstitial space between primary and secondary pipe is not blocked somewhere by flushing air or nitrogen from the test port of the KP T fitting at one end of the pipe run to the test port at the other end of the pipe.
- When using KP T black without test port, check that the interstitial space is not blocked before welding the KP T in place.

Pipe tightness testing - During backfill (recommended)

Objective	Test method	Verification
Get immediate indication of damage caused by backfill operations.	0.02-0.20 bar (0.3-2.9 psi).	Declining pressure indicates leakage.

By maintaining a low pressure in the pipes during backfill operations, any damage caused by operations may be detected at once as sudden pressure changes.

As people will be working close to the piping system during backfill, a pressure of 0.02 bar to maximum 0.20 bar (0.3-2.9 psi) is recommended during this time.

Pipe tightness testing - After backfill (recommended)

Objective	Test method	Verification
Finding any leaks in the system. Temperature changes should be minimal after backfill and pressure stable during the test period.	0.02-0.70 bar (0.3-10 psi) for 1 hour. Adapt the pressure to the resolution of the manometers used.	Bubbles indicate leakage.
	Document pressure during the test period every 10 minutes.	Declining pressure indicates leakage.

After backfill, pressure variations due to temperature changes are reduced to almost zero. A repeated tightness test will confirm that the piping system has not been damaged by backfill operations.

Procedure

- Check that the pipe is blanked off at both ends.
- Pressurize the pipe with air or nitrogen to a pressure of 0.02 to 0.70 bar (0.3-10 psi). Adapt the test pressure to the resolution of the pressure gauges used so that variations in pressure can be read. Vacuum (negative pressure) must not be used.
- Document the starting pressure.
- Document the pressure at 10 minute intervals for a period of 1 hour.

A dropping pressure indicates leakage.

14. Leak detection

The KP 315 leak detection system is a pressure and vacuum free system that uses gravitation for detection of leakage.

The leak detection unit is placed inside the chamber. Any leakage into the interstitial space of hydrocarbon liquids, ethanol, methanol or water will be led down to the leak detection unit and trigger the alarm unit that is placed inside the station building where it can be seen and accessed by the station staff.

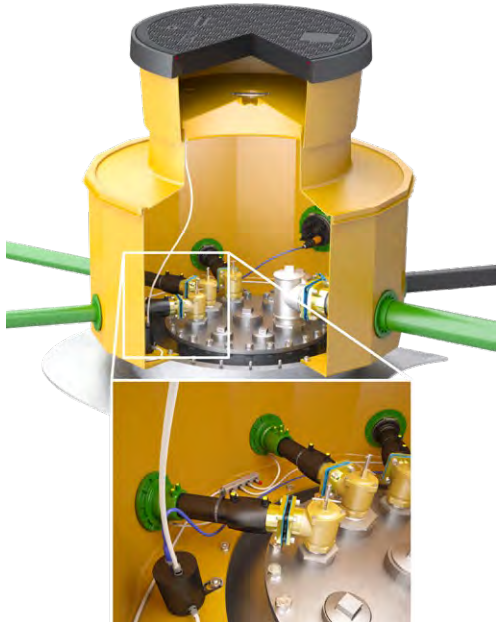

A leak detection unit with a connection block placed inside a tank chamber.

Up to six leak detection units can be connected to each alarm unit. The leak detection unit is provided with one connection port for monitor one pipe line. If there is a need for several pipe lines to be monitored use the manifold block.

Since no compressor or refill of gas bottles is needed the system has a very low maintenance.

The KP 315 leak detection system is very suitable for retrofit on existing filling stations with double wall pipe.

Approved to European standard for leak detection systems EN 13160-4, class 3 by TÜV Nord.



KP 315AU, alarm unit and KP 315LD, leak detection unit.

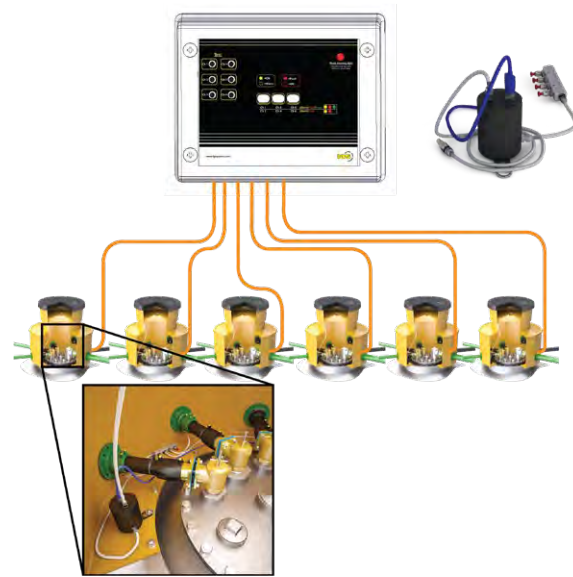

Up to six leak detection units can be connected to one alarm unit.



The leak detection unit should be connected to a KP T or a KP TM.

15. Completing the installation

15.1 Documentation

The KPS Installation Checklist must always be filled in by the installing contractor and saved for the duration of the warranty period. This is a requirement for the KPS product warranty.

It is a strong recommendation to also save the following documentation:

- Documentation of testing.
- Photos of the installation before backfill.
- As-installed-drawing.

15.2 Backfill

Before backfill, make sure pipes are fully supported by sand bags.

Backfill may be undertaken only after successful completion of conductivity, strength and tightness tests. Check that insulation caps have been inserted into all welding sockets and weldable fittings and that pipe arrangement is according to instructions.

Proper backfill supports the pipe, protects it from mechanical damage and handles the effects of thermal expansion/retraction, heavy traffic or other loading imposed on the pipe system and ensures no vapor lock occurs

Recommended backfill materials:

1. Rounded pea gravel of dimension ≤ 16 mm. Well rounded pea gravel is the preferred material since it is self-compacting.
2. Clean sand.



From left to right: Pea gravel and sand.

If sand or shingle is used for bedding and backfill it will need to be mechanically compacted with a machine approximately every 20 cm. Do not compact on top of the pipes until at least 30 cm of backfill material has been put over the pipes.

The optimal layer depth depends on the machine used. Compacting can be done using hand-held tampers, diesel driven impact tampers or vibratory plates. Saturating sand with water can help compacting, but is not sufficient as the only compacting method.

Take care that the pipes are not damaged or moved out of position during compacting. Increase this distance when heavy or powerful devices are used.

The space within 150 mm of the pipes should always be filled with recommended backfill material. All backfill material must be free of organic material, snow, ice or fuel contamination.

The pipe should be buried at a minimum of 300 mm from the top of the pipe to finished forecourt level (250 mm when using reinforced concrete).

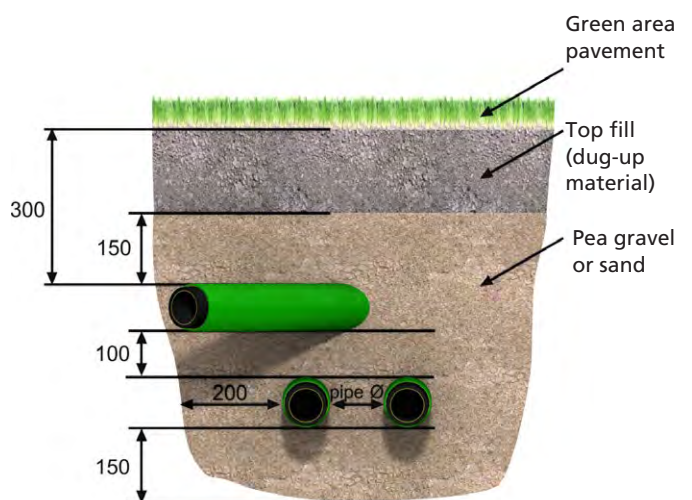

Minimum clearances for green area.

In areas trafficked by vehicles weighing up to 60 tons, the burial depth should be increased to at least 600 mm. If the area is trafficked by vehicles over 60 tons, even deeper burial is needed. Follow standard requirements and regulations for ground work. If local regulations require deeper burial than specified by OPW, these regulations must be followed.

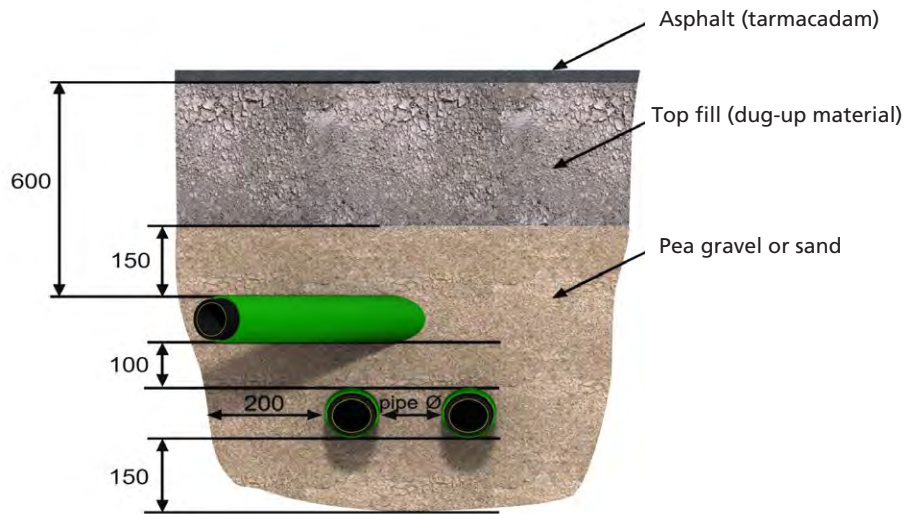

Minimum clearances for vehicles weighing up to 60 tons.

Special attention should be given to backfill under the pipes to make sure there are no voids under the pipe. Compact backfill material under, on the sides of, and in between the pipes for best long term performance.

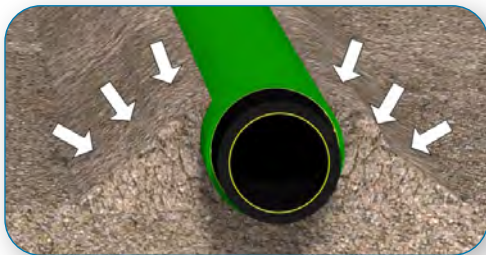

Backfill carefully under the pipes.

16. Modification and repair of installations

16.1 Preparations & safety considerations

It is a strong recommendation that the filling station is closed during any modification or repair works. Access to the site should be restricted and all relevant safety regulations strictly adhered to. Equipment used at the site should be checked to ensure operational condition.

The tanks and the piping system must be emptied and flushed clean or otherwise secured to make sure no fuel or fuel residue or vapors are present where work is to be done.

Electrical equipment such as dispensers and submersible pumps should be disconnected and made safe.

16.2 Modification of existing installations

Adding a conductive pipe to a non-conductive installation

Conductive pipes can be used for a new pipe run of any type (product line, vapor recovery, vent or fill) at an existing site where steel or non-conductive plastic pipes are already installed. There is no risk connected with the installation of a conductive pipe run in these cases.

When a new dispenser island is added to a pressure system, conductive pipes can be used as long as the new pipes are properly connected to earth.

Pipe replacement only

When pipes are replaced but existing tanks, fill point or dispensers are kept, sometimes practical problems occur because the levels and positions are already set.

The following products provide solutions suitable to solve some of the problems that may occur.

- Weldable elbow, conductive or non-conductive

Weldable elbows provide a more compact solution than formed bends, for example under the fill point or ventilation stack, but there will be more turbulence when an elbow is used.

- KP 33-125/110SCC

Is a 90° moulded elbow which provide a more compact solution than formed bends.

- KP T black

Where sumps have not been used and there is not

enough space to install one, secondary containment should be terminated using the black KP T, without test port. KP T:s with test port should not be buried in the ground because of the risk for mechanical damage to the test port.

- Plastic bends and elbows

Plastic bends and elbows can be used to replace steel swivels. The flexibility of the plastic will absorb movement and settlement in the ground.

Adding leak detection at existing installations

The leak detection system (KP 315) is a simple and sturdy leak detection solution that works on gravity. It can be installed without excavation at existing sites with double wall pipes, provided the gradient of pipes are correct and test ports turned downwards. The unit is placed at the lowest point in the tank sump and can be connected to up to eight pipes. Visual and sound alarm signals with optional connection to external alarm systems.

16.3 Repair

Repairing a pipe run

Always repair conductive pipe runs with conductive piping. Non-conductive piping can be repaired at the ends with conductive pipes as long as the conductive part is connected to earth.

Do not mix KPS products with products from other suppliers as interoperability cannot be guaranteed.

When existing pipes are cut using a saw, the pipe end must be cut square using KPS pipe scissors or rotating pipe cutter. Oxide on the pipe surface of existing pipes must also be removed and the pipe cleaned with acetone before welding. Remember to put in the conductor if it's conductive pipes.

KP 2-R, Welding socket for repair

The R welding socket series is suited for repair or upgrading. It comes without the pipe stop inside which makes it easy to slide over an existing pipe. It's available for pipe Ø54, 63, 90 and 110.

KP C14

Compression transition fitting KP C14 can be used instead of a welding socket and transition fitting. No welding is then necessary.

Miscellaneous

When disconnecting flange transition fittings, replace existing gaskets with new ones.

16.4 Pressure testing after modification & repair

The tank must be blanked off from the pipe run before any pressure testing, especially if there is still fuel in the tank.

After modifications or repairs of a system where fuel has been present, only nitrogen must be used for pressure and tightness testing. Never use air or fuel for pressure testing.

Update drawings after modification and repair.

17. Safety considerations

OPW recommends that a job safety analysis is done to assess potential risks for work on site. Appropriate safety measures should then be taken and protective equipment used to prevent accidents, injuries and incidents. Special attention should be paid to safety in potentially hazardous areas when doing repair, maintenance or upgrading work.

17.1 Releasing & cutting coils

Be careful when releasing coils as the pipe can straighten with considerable force. A minimum of two people is needed to uncoil the pipe. The end of the pipe should be constrained with a rope and a slipknot before cutting the bands around the coil.

- When cutting coils, one person should do the cutting and another person should hold the pipe.
- Uncoil pipes the day before installation. To help straighten the pipe it can be tied at either end to solid fixings.
- The natural curves of a coiled pipe can be used to change direction of the pipe or to achieve the correct angle for entry into a sump. Bags filled with pea gravel or stakes can be used to keep it in position until installation and backfill.



One person should hold the pipe and another do the cutting.

Be careful when cutting pipe that have been coiled, even if it has already been uncoiled as the cut ends tend to bend back into a curved form and risk hitting you or others causing injury. One person should do the cutting while another person holds the pipe.

17.2 Use of equipment

To avoid personal injury, exercise caution when using cutting tools.

The welding machine and test equipment must not be used in hazardous areas, including areas where fuel vapors are present.

Always perform the conductivity test in an area free from flammable liquids or vapors.

17.3 Pressure testing

Follow any local, national or regional regulations and make a risk assessment before applying high pressures.

Use nitrogen for pressure and tightness testing whenever fuel has been present in the system.

Blank off the pipe from the tank before pressurizing. Do not pressurize a tank with fuel in it.

17.4 Repair, maintenance & upgrading work

Before starting modification and repair work, make detailed risk assessments and take due precautions to eliminate or minimize risks. Follow all applicable health and safety regulations and make sure permit-to-work systems are in place.

It is a strong recommendation that the filling station is closed during any modification or repair works. Access to the site should be restricted and all relevant safety regulations strictly adhered to. Equipment used at the site should be checked to ensure operational condition and suitability for intended use.

The tanks and the piping system must be emptied and flushed clean or otherwise secured to make sure no fuel or fuel residue or vapors are present where work is to be done. Electrical equipment such as dispensers and submersible pumps should be disconnected.

Suggested approach to welding



CAUTION: Additional safety measures may be necessary depending on site conditions. Area must be made safe!

- Remove or prevent a hazardous atmosphere during welding and conductivity test by flooding sumps and pipes with nitrogen.
- Make sure there is enough oxygen in the sump to enter by using a gas detector. Enter the sump and connect the welding cables to the welding socket. The welding machine must NOT be connected to the power supply in this moment.
- Flush the pipes with nitrogen to remove all oxygen, check with the gas detector.
- Connect the welding cables to the welding machine, and place the welding machine as far from the sump as possible during welding.
- Connect the welding machine to the power supply and start the welding procedure.
- After completing the welding disconnect the power supply from the welding machine.
- Before entering the sump exchange the air and check that the oxygen level is above 21%. No personnel shall enter the sump before this point.
- Enter the sump and disconnect the welding cables from the welding socket.

17.5 Hazardous substances

Acetone



WARNING: Acetone creates a potentially hazardous situation that result in serious injury.

- Acetone can affect you when breathed in and may be absorbed through the skin.
- Contact can irritate the skin. Repeated skin exposure can cause dryness and cracking of the skin.
- Exposure can irritate nose, eyes and throat.
- Exposure to a high concentration can cause headache, dizziness, nausea, vomiting and even passing out.
- Acetone is a flammable liquid and a fire hazard.

Petrol



WARNING: Petrol creates a potentially hazardous situation that result in serious injury.

- Petrol can affect you when breathed in and by passing through your skin.
- High exposures during pregnancy may damage the developing fetus.
- Contact can irritate and burn the skin and eyes with possible eye damage.
- Prolonged contact can cause a rash with drying and cracking of the skin.
- Breathing petrol can irritate the nose and throat causing coughing and wheezing.
- High levels can cause headache, nausea, dizziness, blurred vision, irregular heartbeat, poor coordination, seizures, coma, and even death.
- Repeated high exposure may cause lung and brain damage.
- Petrol may damage the kidneys.
- Petrol is a flammable liquid and a dangerous fire hazard.
- Petrol can contain lead and benzene.

Diesel



WARNING: Diesel creates a potentially hazardous situation that result in serious injury.

- Diesel can affect you when inhaled and may pass through the skin.
- Contact can irritate the skin and eyes.
- Inhaling diesel can irritate the nose, throat and lungs.
- Diesel can affect the nervous system causing headache, dizziness, and loss of balance and coordination.
- Diesel may affect the liver and kidneys.

Ways of reducing exposure to hazardous substances



CAUTION: Additional safety measures may be necessary depending on site conditions.

- Work in a well ventilated area.
- Wear protective clothing.
- Wash thoroughly immediately after exposure and at the end of the work day.

First aid

- Make the person in danger safe.
- Seek immediate help.

18. Main updates from version 8.0

This version of the installation manual has been partly revised. We recommend that the complete contents are studied carefully before installation of the KPS Petrol Pipe System™ commences.

- Tanks and chambers removed
- Anaconda removed
- New products added
- Standard drawings updated
- Minor text changes entire manual
- System overview shortened

19. Appendices

- 19.1 OPW Suction line single wall example
- 19.2 OPW Suction line double wall example
- 19.3 OPW Pressure line example
- 19.4 OPW Fill line example
- 19.5 OPW VR stage I/Vent line example
- 19.6 OPW VR stage II example
- 19.7 Pipe installation checklist
- 19.8 Pipe test document
- 19.9 Pressure testing document

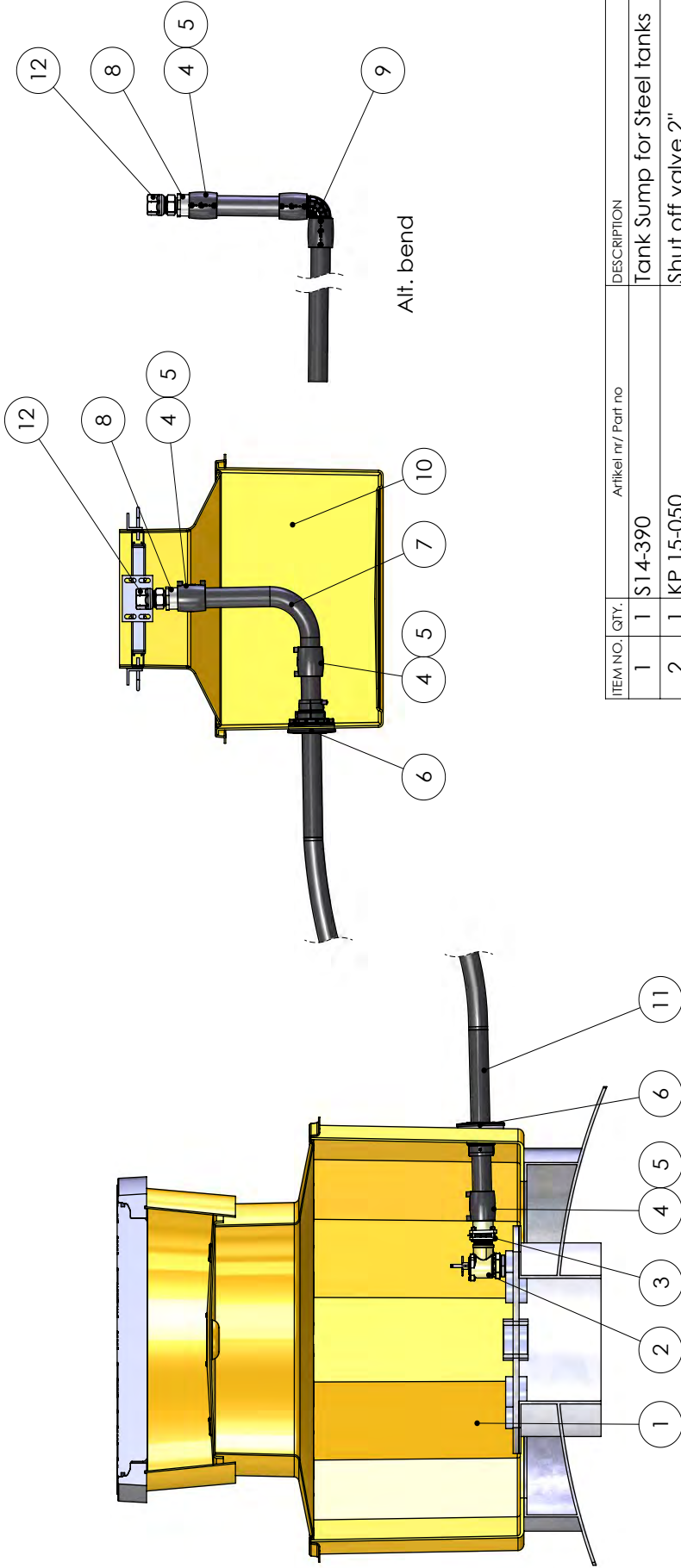

ITEM NO.	QTY.	Artikel nr/ Part no	DESCRIPTION
1	1	S14-390	Tank Sump for Steel tanks
2	1	KP 15-050	Shut off valve 2"
3	1	KP C16-63M	Transition fitting 63mm
4	4	KP 2-63	Welding socket 63 mm
5	4	KP CC-63	Conductor 63 mm, conductive
6	2	KP TM63-B	Entry seal Ø63 B
7	1	KP 3-63FCL	Bend 90° 63 mm, conductive, long type
8	2	KP C17-63/54M	Transition fitting Ø53/54 steel. 1/2"BSPT
9	1	KP 23-63EC	Elbow 90° 63 mm, conductive
10	1	EL/T/Q510-4/8	GRP solid base sump and corbel
11	1	KP 63EC	Pipe 63 mm, conductive
12	2	70-007L	OPW 70 Vertical Check Valve 1-1/2" BSP

	Drawn by	Approved				Scale 1:15
	KPS					

Title Suction_line single wall OPW		Art.no
Title swe Suction_line single wall OPW		Project
Drawing number Suction_line single wall OPW		Revision
		Drawn date 2016-06-10

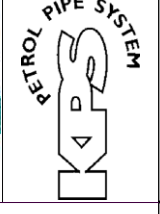

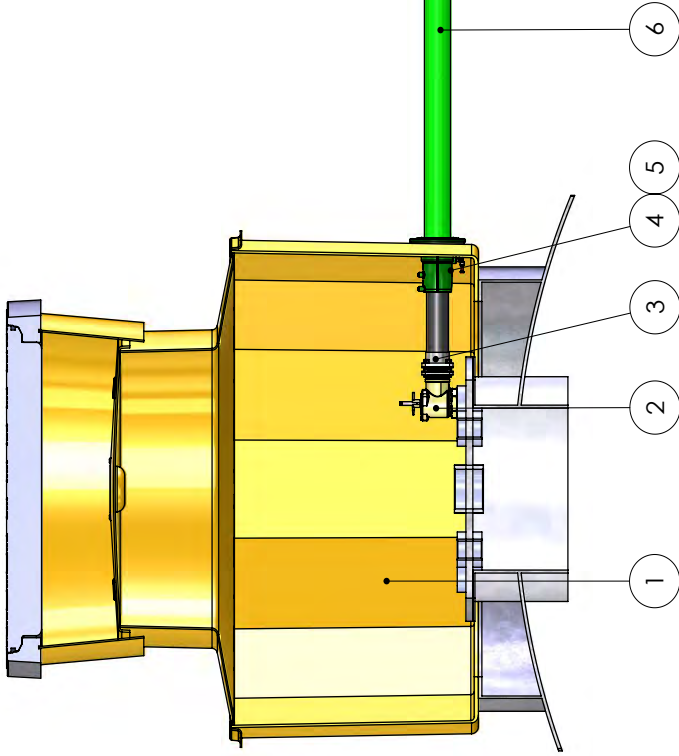
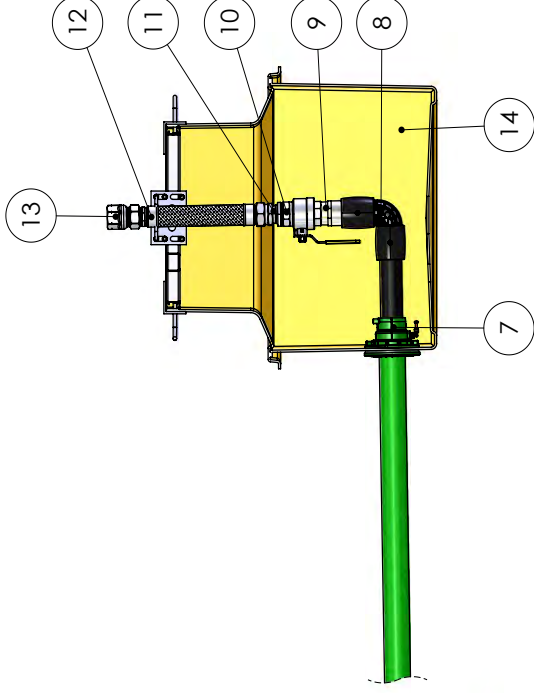

ITEM NO.	QTY.	Artikel nr / PartNo	DESCRIPTION
1	1	S14-390	Tank Sump for Steel tanks
2	1	KP 15-050	Shut off valve 2"
3	1	KP C16-63ML	Transition flange fitting Ø63 to R2" long
4	1	KP TM75-63SC2A-L	Entry seal and termination fitting long, two welds, 90° festport
5	1	KP CC-63	Conductor 63mm
6	1	KP 75/63SCEC	Pipe 75/63 mm, secondary contained, conductive
7	1	KP TM75/63SC2B	Entry seal/term fitting, straight festport
8	1	KP 23-63EC	Weldable Elbow 90° conductive
9	1	KP C17-63M	Transition fitting Ø63 male
10	1	KP 14-050	Ball valve 2"
11	1		Reducing hexagon nipple, galvanized steel
12	1	KP T40-4S	Flex hose 400 mm, stainless
13	1	70-007L	OPW 70 Vertical Check Valve 1-1/2" BSP
14	1	EL/T/Q510-4/8	GRP solid base sump and corbel

Drawn by: **KPS** Approved
 General tolerance:
 Format: **A3** Scale: **1:15**

Title: **Suction line double wall OPW**
 Project: **RETROL PIPE SYSTEM**
 Drawing number: **Suction_line_75_63_OPW**
 Revision: **2016-06-10**

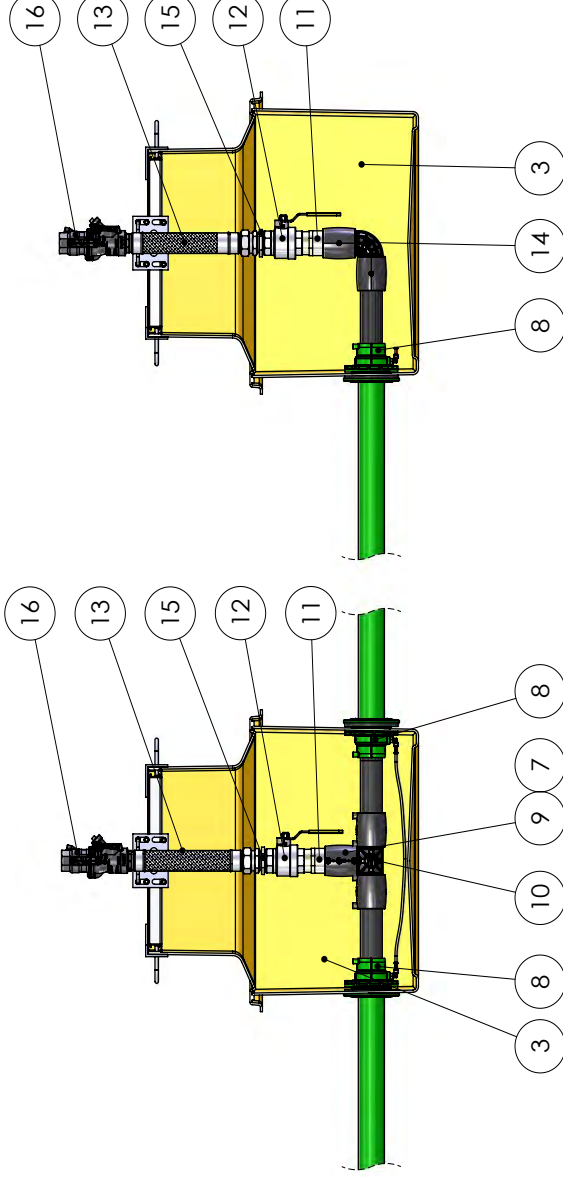
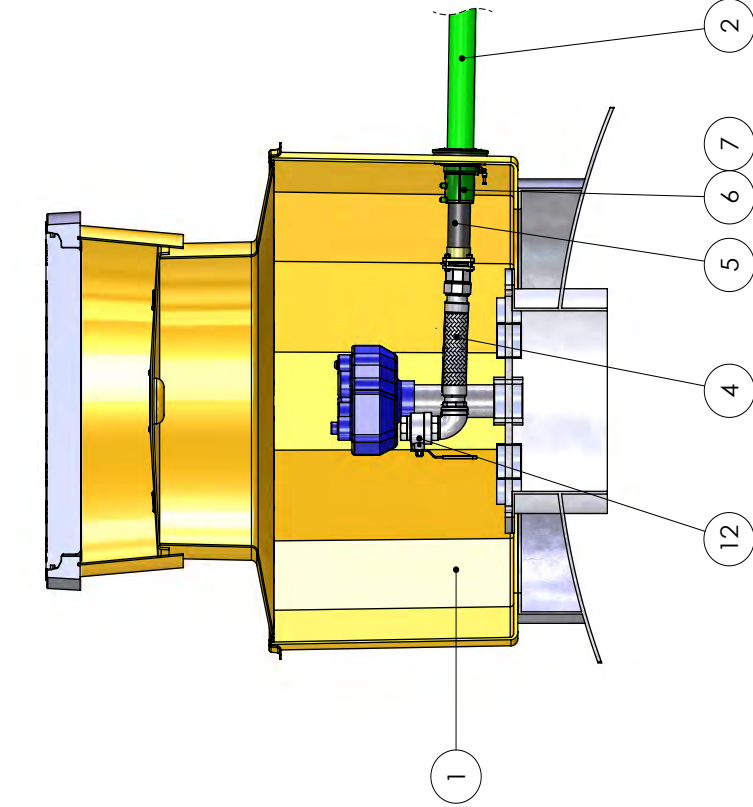

ITEM NO.	QTY.	PartNo	DESCRIPTION
1	1	S14-390	Tank Sump for Steel tanks
2	1	KP 75/63SCEC	Pipe 75/63 mm, secondary contained, conductive
3	2	EL/T/Q510-4/8	GFR solid base sump and corbel
4	1	KP TN50-4S	Flex hose 400 mm, stainless
5	1	KP C16-63ML	Transition fitting 50cm stub, 63mm, steel
6	1	KP TM75-63SC2A-L	Entry seal and termination fitting long, two welds, 90° festport
7	2	KP CC-63	Conductor 63 mm, conductive
8	3	KP TM75/63SC2A	Entry seal and termination fitting, 90° festport
9	1	KP 2-63	Welding socket 63 mm
10	1	KP 28-63EC	Tee 63 mm, conductive, weldable
11	2	KP C17-63M	Transition fitting Ø63 male
12	3	KP 14-050	Ball valve 2"
13	2	KP T40-4S	Flex hose 400 mm, stainless
14	1	KP 23-63EC	Elbow 90° 63mm, conductive
15	2		Reducing hexagon nipple, galvanized steel
16	2	10P-0152L	1-1/2" BSP, 10 Plus Shut Off Valve, Double Poppet

		Drawn by KPS	Approved	General tolerance 	Format A3	Scale 1:15
Title Pressure line double wall OPW				Art.no -		Project
Title swe 				Drawing number Pressure_line_OPW		Revision
Drawing number Pressure_line_OPW				Drawn date 2016-06-10		2016-06-10

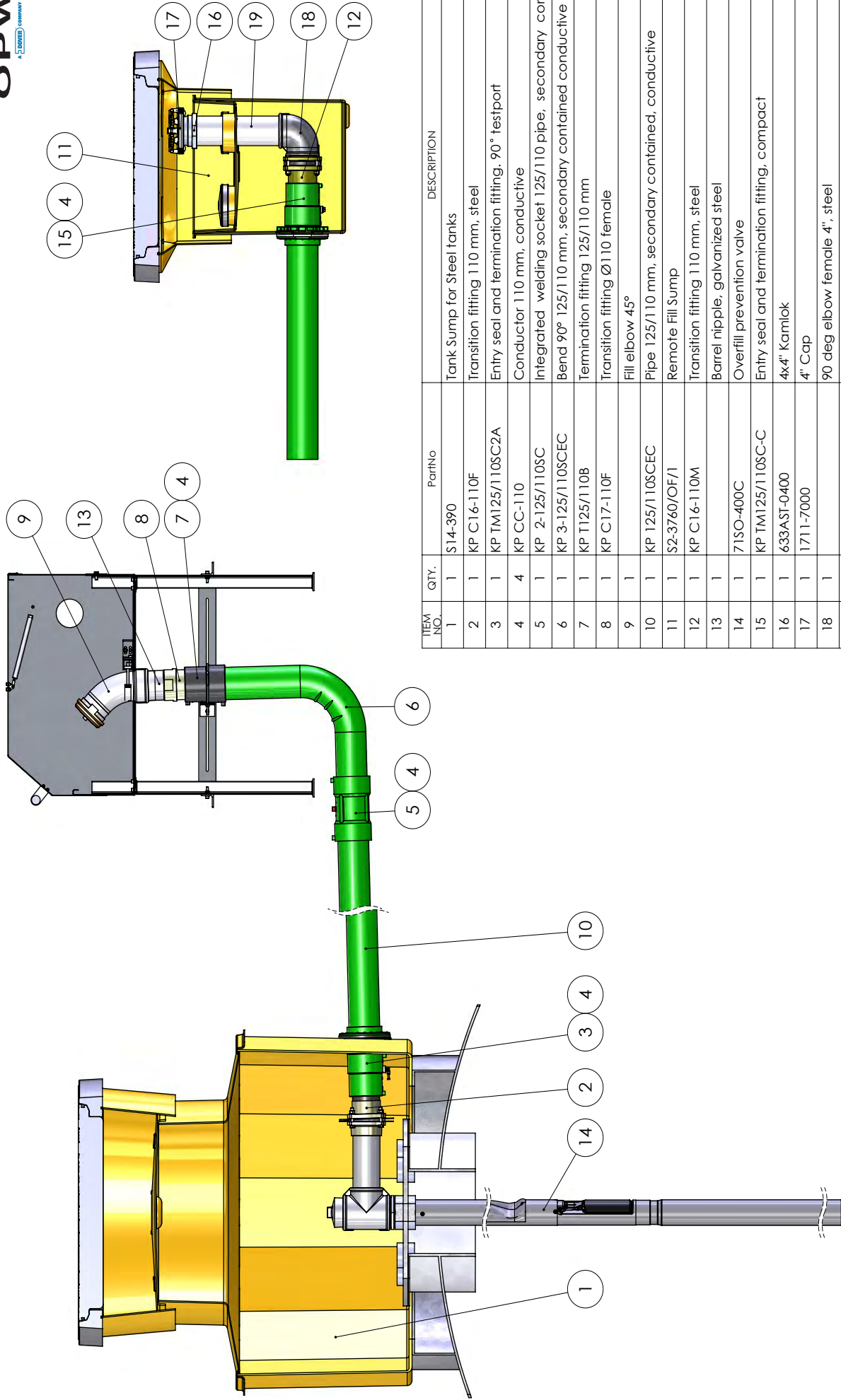

ITEM NO.	QTY.	PartNo	DESCRIPTION
1	1	S14-390	Tank Sump for Steel tanks
2	1	KP C16-110F	Transition fitting 110 mm, steel
3	1	KP TM125/110SC2A	Entry seal and termination fitting, 90° festport
4	4	KP CC-110	Conductor 110 mm, conductive
5	1	KP 2-125/110SC	Integrated welding socket 125/110 pipe, secondary contained
6	1	KP 3-125/110SCEC	Bend 90° 125/110 mm, secondary contained conductive
7	1	KP T125/110B	Termination fitting 125/110 mm
8	1	KP C17-110F	Transition fitting Ø110 female
9	1		Fill elbow 45°
10	1	KP 125/110SCEC	Pipe 125/110 mm, secondary contained, conductive
11	1	S2-3760/OF/1	Remote Fill Sump
12	1	KP C16-110M	Transition fitting 110 mm, steel
13	1		Barrel nipple, galvanized steel
14	1	71SO-400C	Overfill prevention valve
15	1	KP TM125/110SC-C	Entry seal and termination fitting, compact
16	1	633AST-0400	4x4" Kamlok
17	1	17111-7000	4" Cap
18	1		90 deg elbow female 4", steel
19	1		4" Steel pipe

Drawn by **KPS** Approved
 Title **Fill line OPW**
 Art.no **-**
 Project **Project**
 General tolerance **A3** Scale **1:15**
 ISO 3281:1982
 Revision **2016-06-10**
 Drawing number **Fill_line OPW**
 Drawn date **2016-06-10**
 Revision **2016-06-10**
 Project **Project**
 Drawing number **Fill_line OPW**
 Drawn date **2016-06-10**
 Revision **2016-06-10**

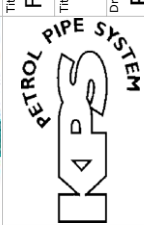

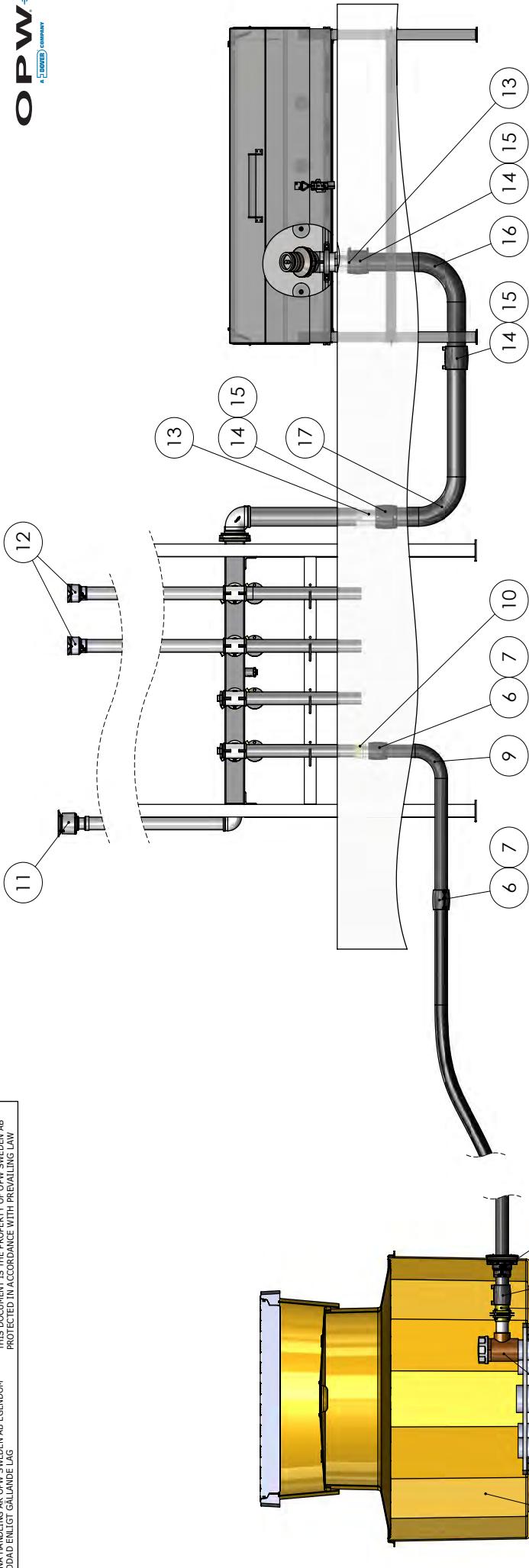

ITEM NO.	QTY.	PartNo	Description
1	1	S14-390	Tank Sump for Steel tanks
2	1	KP 3KR3-2	Extractor
3	1	KP BZ3-2	Reducer for extractor
4	1	KP KYDN50	Ball float vent valve
5	1	KP C16-63F	Transition fitting 63 mm, steel
6	3	KP 2-63	Welding socket 63 mm
7	3	KP CC-63	Conductor 63 mm, conductive
8	1	KP TM63-B	Entry seal Ø63 B
9	1	KP 3-63FCL	Bend 90° 63 mm, conductive, long type
10	1	KP C17-63F	Transition fitting Ø63 female
11	1	523V-1100	2" Pressure / Vacuum vent
12	2	23-0044	1-1/2" Open atmospheric vent
13	2	KP C17-90F	Transition fitting Ø90 female
14	3	KP 2-90	Welding socket 90 mm
15	3	KP CC-90	Conductor 90 mm, conductive
16	1	KP 3-90FC	Bend 90° 90 mm, conductive
17	1	KP 3-90FCL	Bend 90° 90 mm, conductive, long type

		Scale 1:20
	Approved KPS	General tolerance A3
Title VR Stage I / Vent line OPW		Art.no
Title svs 		Project
Drawing number Stage_I_Vent_line_OPW		Revision 2016-06-10

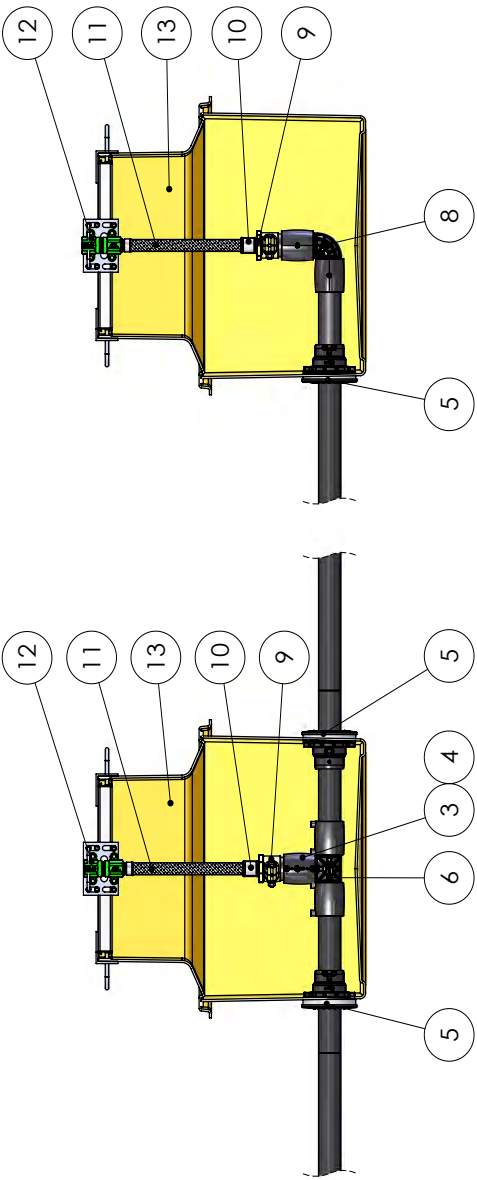
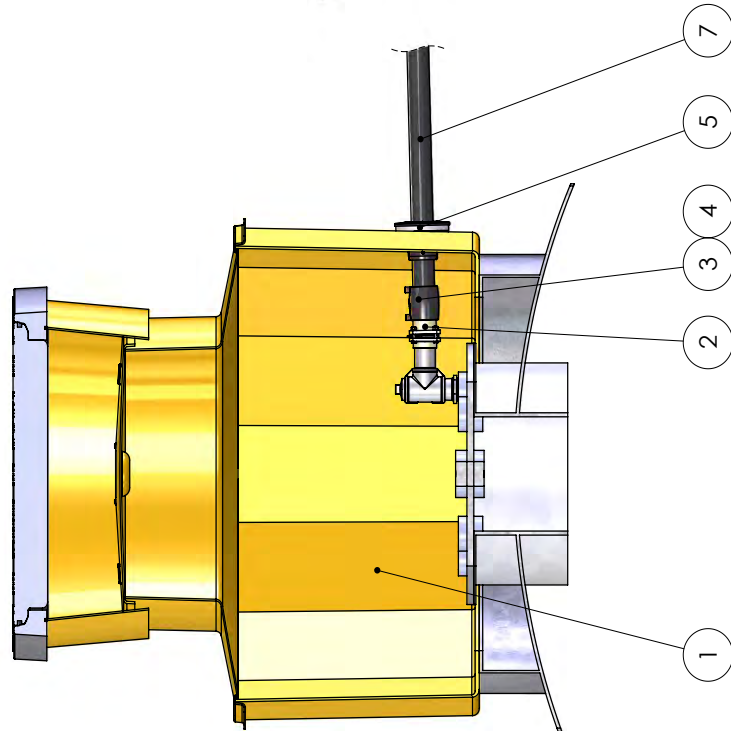

ITEM NO.	QTY.	PartNo	DESCRIPTION
1	1	S14-390	Tank Sump for Steel tanks
2	1	KP C 16-63M	Transition fitting 63 mm, steel
3	2	KP 2-63	Welding socket 63 mm
4	2	KP CC-63	Conductor 63 mm, conductive
5	4	KP TM63-B	Entry seal Ø63 B
6	1	KP 28-63EC	Tee 63 mm, conductive, weldable
7	1	KP 63EC	Pipe 63 mm, conductive
8	1	KP 23-63EC	Elbow 90° 63mm, conductive
9	2	KP C 14-63/25M	Transition fitting 63/25 mm, reduced, brass
10	2		Parallel socket, galvanized steel
11	2	KP TN25-4S	Flex hose 400 mm, stainless
12	2	60VP-101L	Shear valve
13	2	EL/T/Q510-4/8	GRP solid base sump and corbel

	Drawn by	KPS	Approved	General tolerance		Format	A3	Scale	1:15
	Title		Stage II Vapour recovery OPW		Art.no		Project		
Title swe		Stage II Vapour recovery OPW		Revision		Drawn date			
Drawing number		Stage II Vapour recovery OPW		Revision		2016-06-10			



PIPE INSTALLATION CHECKLIST

To be completed and filed by the installing contractor during the warranty period.

<p>Installing Contractor Information:</p> <p>Installer: _____</p> <p>Address: _____</p> <p>Phone: _____</p> <p>Contact: _____</p>	<p>Site Information:</p> <p>Owner: _____</p> <p>Site address: _____</p> <p>Phone: _____</p> <p>Contact: _____</p>
--	--

- All KPS products used for installation were checked upon arrival at the site and free from freight and handling damages.
- All KPS products were handled with care during unloading and installation.
- All pipe trenches were excavated to provide a minimum of 10 cm free space on either side of every pipe and minimum 20 cm free space to the trench wall.
- All pipes have been installed on a correctly prepared, 10-15 cm, thick, bed of pea gravel (≤ 16 mm) or compacted sand.
- All KPS pipes were cut squarely with KPS recommended pipe scissors or pipe cutters.
- Oxides were removed from the welding area of all KPS pipes, tees, bends and fittings by scraping.
- All KPS pipes, tees, bends, fittings and welding sockets were cleaned with acetone or isopropanol before welding.
- All KPS pipes/bends/tees/fittings were marked with the correct insert depth and pushed to the bottom of the welding socket before welding.
- All KPS pipes/bends/tees/fittings and sockets were fixated during welding and allowed to cool down after welding.
- All KPS welding sockets were marked upon completion of welding.
- All pipes were installed in accordance with the KPS installation manual in order to allow for expansion and contraction.
- Conductivity test on all conductive pipes is performed according to the KPS installation manual.
- Pressure test (of pressure lines) and tightness test (of all lines) with soaping has been performed in accordance with the KPS installation manual and no leaks were detected.
- All backfill material consists of pea gravel (≤ 16 mm) or sand and the backfill has been performed according to the KPS installation manual.
- All parts in the pipe work system are KPS products or products distributed by KPS and were installed in accordance with the KPS installation manual.
- Information in section, "Earthing and Static Electricity", has been taken into account.
- Installing Contractor acknowledges that the warranty will be void unless a certified installer i.e. trained and approved by a KPS approved instructor, has carried out the installation.

Certified Installer (license number, signature and company name)

Installing Contractor (signature and company name)

Print Name

Date

Print Name

Date

Pipe test document



Site information: Station: Address: Phone: Contact:	Installer information: Company: Address: Phone: Contact:
--	---

Conductivity test: Inner pipe only
 Strength test: 5.0 bar (72,5psi) for 5 minutes
 Tightness test: 0.02 - 0.70 bar (0.29 psi - 10.15 psi) for 1 hour + soaping

For more information see KPS Petrol Pipe System installation manual

Pipe line		Fill line		Ventilation		VR Stage 2		VR Stage 1B		1		2		3	
		Inner pipe	Outer pipe	Inner pipe	Outer pipe	Inner pipe	Outer pipe	Inner pipe	Outer pipe	Inner pipe	Outer pipe	Inner pipe	Outer pipe	Inner pipe	Outer pipe
1	Conductivity														
	Strength														
	Tightness														
2	Conductivity														
	Strength														
	Tightness														
3	Conductivity														
	Strength														
	Tightness														
4	Conductivity														
	Strength														
	Tightness														
5	Conductivity														
	Strength														
	Tightness														

Pipe line		4		5		6		7		8		9		10	
		Inner pipe	Outer pipe	Inner pipe	Outer pipe	Inner pipe	Outer pipe	Inner pipe	Outer pipe	Inner pipe	Outer pipe	Inner pipe	Outer pipe	Inner pipe	Outer pipe
1	Conductivity														
	Strength														
	Tightness														
2	Conductivity														
	Strength														
	Tightness														
3	Conductivity														
	Strength														
	Tightness														
4	Conductivity														
	Strength														
	Tightness														
5	Conductivity														
	Strength														
	Tightness														

..... Certified installer (license number and signature) Print name Date
---	---------------------	---------------

Pressure testing single or double wall pipe

Site information: Station: Address: Phone: Contact:	Installer information: Company: Address: Phone: Contact:
--	---

Temperature: °C <input type="checkbox"/> °F <input type="checkbox"/> Pressure bar <input type="checkbox"/> psi <input type="checkbox"/>	Time in minutes						
	0	10	20	30	40	50	60
Tested pipes							
Pipe line:							
Temperature:							
Pressure inner pipe:							
Temperature:							
Pressure outer pipe:							
Pipe line:							
Temperature:							
Pressure inner pipe:							
Temperature:							
Pressure outer pipe:							
Pipe line:							
Temperature:							
Pressure inner pipe:							
Temperature:							
Pressure outer pipe:							
Pipe line:							
Temperature:							
Pressure inner pipe:							
Temperature:							
Pressure outer pipe:							

Note: when testing single wall pipes, only fill in rows for inner pipe

Soaping:	Yes <input type="checkbox"/>	No <input type="checkbox"/>	Tightness confirmed:	Yes <input type="checkbox"/>	No <input type="checkbox"/>
.....		
Certified installer (license number and signature)		Print name		Date	



20. Extended warranty

OPW Sweden AB, Fabriksgatan 3, 736 22 KUNGSÖR, Sweden ("the Seller"), warrants that all KPS branded pipes and KPS branded accessories ("the Goods") sold by it which are incorporated into a KPS system as defined herein, shall be free from defects in material and workmanship and are fully in conformance with our published technical specifications current at the date of the sale of the Goods or as otherwise specified in writing by the Seller at that time.

With reference to the above the Seller warrants that for the following categories of the Goods the following time period terms apply:

Petrol pipe	15 years
Petrol pipe plastic fittings	15 years
Steel to plastic transition fittings	2 years
Entry boots	2 years
Fibreglass sumps and chambers	5 years
Fibreglass covers	2 years
All other products and accessories	1 year

From the date of delivery of the Goods to the Buyer ex works.

The KPS system shall consist of KPS Supply Pipe, Vent Pipe and Fill Pipe installed with KPS, Fibrelite or OPW brand Tank Chambers and Dispenser/Pump sumps, KPS, Fibrelite or OPW branded Entry Boots together with a third party approved leak detection system in accordance with EM 13160 including chamber and sump liquid sensors. Fittings must be protected from exposure to water, petrol or other aggressive media over the warranty period in order for the warranty to be valid. KPS primary pipe is designed to convey petroleum fuels, while the KPS secondary contained area and the outer layer of the KPS pipe is NOT designed for to be exposed to fuels or fuel vapors.

In the case of any defect found in the Goods in the terms of this warranty during the applicable warranty period the Buyer shall notify the Seller in writing within 28 days of the Buyer becoming aware of the defect giving a description of the defect, place of purchasing the Goods, evidence of the date of the sale of the Goods by way of original receipt or receipted invoice, copies of the certification of the installer and a copy of the properly and completely filled installation check list. On receipt of such notification the Seller shall be allowed a reasonable period to investigate the complaint and the defective Goods. If no defect is found for which the Seller is liable under this warranty, the Seller shall be entitled to compensation for the costs it has incurred as a result of the notification.

Any Goods found by the Seller to be defective in the terms of this warranty shall, at the Seller's expense, be repaired or replaced by new by the Seller. Otherwise such costs and any other costs associated with remedial work shall be borne by the Buyer. This warranty shall apply in the same terms to Goods replaced or repaired under the terms of this warranty for the remainder of the applicable warranty period.

The Seller shall only incur liability under this warranty if the Goods, before refilling of trenches and taken into use, have been installed, tested and accepted in accordance with standard Installation Procedures published by the Seller and in accordance with any specifications from local authorities.

The Seller's liability under this warranty does not cover defects arising from any specification supplied by the Buyer or defects which are caused by faulty maintenance, incorrect erection or faulty repair or other action by the Buyer or any person unauthorised by the Seller, or by alterations carried out without the Seller's consent in writing. The Seller's liability does not cover normal wear and tear, deterioration, wilful damage, negligence or misuse.

Subject as provided for by this warranty, all other warranties, conditions or other terms express or implied are excluded to the fullest extent permitted by law. The Seller shall incur no liability under this warranty to the Buyer or to any third party for any further claims the Buyer or any third party may have for consequential loss or other economic, indirect or special losses (including but not limited to loss of profit, loss of production and loss of use), costs, expenses or other claims for compensation whatsoever arising out of or in connection with the sale of the Goods or their use or resale.

The Goods shall be used in compliance with applicable national and local standards, laws, directives and applicable health, safety and environmental regulations. Product selection shall be based on physical specifications and limitations and compatibility with the specific site environment and the material to be handled. Materials and specifications are subject to change at any time and models may be discontinued at any time, in either case without notice or obligation.

This warranty is in lieu of all other warranties, express or implied, and specifically the warranties of merchantability and fitness for a particular purpose and it shall be construed and take effect according to the laws of Sweden.

Kungsör, Sweden, January 2016

OPW AB

21. KPS Petrol Pipe System certifying installer training

It is an important part of the OPW strategy to ensure that sites are installed in accordance with best practice in order to achieve underground fuel systems that will operate for many years without problems.

Description

This training is for installers who work with or who will work with installation of the KPS Petrol Pipe System™. It combines practical training with theoretical instruction and group exercises.

All trainers running the Certifying Installer Training has been trained, tested and authorized by OPW to secure high quality training for all our installers globally.

Course objectives

After participating in the course you will have a better understanding of the petrol station system. You will know what signifies a good installation, how pipes should be arranged, what installation solutions that can be recommended and select the solution best fitted for the different types of installations.

You will be able to perform welds of both single and double walled piping using electro fusion sockets in a way that guarantees best possible installation quality and reliability.

You will know how to test the installation so that you can validate and document the correctness and quality of your work.

Certification

The course ends with a theoretical and a practical certification test. Participants that pass both tests will become KPS Certified Installers and receive the installer certification badge. The certification is valid for three years.

Contents

- The petrol station
- Safety
- Handling and storage
- Preparing for installation
- Arranging the pipes
- Joining pipes
- Entry seals
- Tank lid connections
- Pressure and tightness testing
- Static electricity
- Conductivity testing
- Completing the installation
- KPS products
- OPW products
- Tools and installation equipment
- Theoretical certification test
- Practical certification test

Who should attend?

Everyone in any way involved in installing the KPS Petrol Pipe System™. The KPS product warranty requires that installation is made by a certified installer.

Duration

2 Days

Course fee

Ask your OPW contact for more information



22. Approvals

OPW work hard to maintain our position at the forefront of product development in the petrol pipe industry in order to provide the best possible solutions to our customers. We constantly participate in the development of relevant rules and guidelines for our industry, but also strive to develop products that will exceed these and set new, higher standards. It is this long-term commitment to constantly pushing the boundaries of what is possible that has rewarded our products with the markets broadest range of approvals.

KPS was the first company on the market to receive the **EN 14125 approval**. This pan-European standard for petrol piping specifies the properties of thermoplastic and flexible metal pipe work for underground installation at petrol filling stations. The standard particularly sharpened the demands and requirements on permeation. In 2008 France became the first country to adopt the EN 14125 standard as a mandatory requirement, and more and more European countries are looking to incorporate this standard in their local regulations.

KPS approvals to major industry standards

EN 14125	Thermoplastic and flexible metal pipework for underground installation at petrol filling stations
EN 13463-1	Non-electrical equipment for potentially explosive atmospheres
DIBt	German approval for secondary containment plastic pipe system, for underground installation in filling stations.
ATEX 137	ATEX workplace safety directive
EN 13160	Leak detection system
UL 971	Nonmetallic underground piping for flammable liquid
IP 2	Institute of Petroleum performance specification for underground pipe work systems at petrol filling stations

KPS products also comply with the Swedish Ethanol Approval, as well as several other local type approvals issued by relevant authorities.

Our approvals are constantly being updated to meet our customers' requirements, comply with environmental legislation and codes of practice.



Operations in Europe,
Middle East and
Africa

1 OPW Sweden AB

Box 70
736 22 Kungsör
Sweden
+46 227 422 00

3 Fibrelite Composites Ltd

Snaygill Industrial Estate
Keighley Road, Skipton
North Yorkshire BD23 2QR
United Kingdom
+44 1756 799 773

5 OPW CIS

Gilyarovskogo str. 4,
office 303
Moscow 129090
Russia
+7 495 287 96 99

7 OPW FMS Poland

Petro Vend sp. z o.o.
ul. Warszawska 184
32-086 Węgrzce
Poland
+48 12 4106600

2 OPW Czech Republic

Dover CR spol. s.r.o.
Prumyslova 4
431 51 Klasterec nad Ohri
Czech Republic
+420 474 624 025

4 OPW France

KPS France
73 avenue Carnot
FR-94230 Cachan
France
+33 1 4663 0400

6 OPW Slovakia

KPS CEE s.r.o
Antolská 4
SK-85107 Bratislava
Slovakia
+42 1 911 886 613

OPW Retail Fueling

Components and products to protect the environment and the consumer at retail fueling sites for conventional and alternative fuels.

OPW Electronic Systems

Innovative electronic tank gauges and fuel control systems to ensure customers know how much fuel they have and where it is going. Also, Automated Vehicle Wash Systems.

OPW Chemical & Industrial

Safe and efficient loading and unloading of critical hazardous chemicals: loading arms, swivel joints, sight flow indicators, quick and dry disconnect couplers, and safety breakaways.

OPW Transportation

Components and systems for use on Tank Trucks and Rail Tank Cars to ensure the safe handling, loading, transport and unloading of hazardous bulk products, including: petroleum, chemical and dry bulk cargo.